



ISCO®

HDPE FUSION MANUAL



Q1 2024

TABLE OF CONTENTS

- Fusion Equipment Safety P2
- Tips for Success P14
- Manual Butt Fusion Machine Procedure P18
- Hydraulic Butt Fusion Machine Procedure.....P34
- Saddle Fusion Machine ProcedureP56
- Socket Tooling & Fusion ProcedureP70
- Reference InformationP82
 - Power Requirements P83
 - Pipe Size Reference Charts P85-86
 - Cold & Inclement Weather Procedures P87
 - Hydraulic Fluid Characteristics Chart P87-89
 - Saddle Fusion Heater Adapter Code System P90-91
 - DataLogger® 6 & 7 Operation P92-99
 - Fusion Pressure Charts P100-109
 - Conversion Information..... P110
 - Reference & Acknowledgments..... P111

Welcome to the ISCO Industries, Inc. (ISCO) Fusion Manual. The procedures shown are based on ASTM F2620, which originates from the Plastic Pipe Institute (PPI) document TR-33, “Generic Butt Fusion Joining Procedure for Field Joining of Polyethylene Pipe” and TR-41, “Generic Saddle Fusion Joining Procedure for Polyethylene Gas Piping” HDPE pipe and fittings manufacturers have previously approved PPI’s Generic Joining Procedures to standardize the joining procedures of HDPE. For socket fusion, ASTM standard F1056 is referenced. **DO NOT join Driscopipe 7000 or 8000 series products using these procedures. Refer to the cold weather guidance of ASTM F2620 when performing socket, saddle, and butt fusions in extreme cold conditions.**

ISCO is proud to offer quality products, services, and a team of skilled professionals worldwide, dedicated to providing exceptional customer service, especially our fusion equipment, sales, rental, repair, refurbishment, and training support system. If you have questions about fusion, please call our toll-free hotline at 1-800-345-ISCO (4726) ext. 4790.

The ISCO Fusion Manual is endorsed by McElroy Manufacturing, Inc. However, this manual should not be considered a substitute for the original manufacturer’s fusion equipment manuals. Always read and understand the original manufacturer’s equipment manual before operating any piece of equipment.

The operator must be thoroughly trained in the proper use of fusion equipment and procedures. We are proud to be a distributor of McElroy Fusion Equipment and feature their equipment in this manual. ISCO is geared towards educating everyone with the proper fusion procedures so that HDPE can continue to grow in the marketplace as the piping material of choice. The operator’s training and judgement is paramount to the success of fusing HDPE products. ISCO offers training to our customers that complies with ASTM F3190. The appropriateness of the procedures involved should be considered before starting any project. We hope this manual aids in the safe handling and joining of HDPE products in a more effective and efficient manner.

ISCO has multiple certifications from external organizations which are available on www.isco-pipe.com. ISCO is certified by Factory Mutual (FM) to provide FM products and is ISO 9001:2015 certified. Each certification requires robust Quality Management documentation and controls such as quality checks and periodic internal and external audits to ensure superior quality.

If you have any questions regarding this manual or joining HDPE pipe, please contact our Fusion Hotline at 1-800-345-ISCO (4726), ext. 4790 from 8 a.m. to 7 p.m. EST Monday-Friday.

This manual contains accurate information to the best of our knowledge as of the publication date. The results of using our suggestions and recommendations cannot be guaranteed because the conditions of use are beyond our control. Failure to follow these procedures in this manual may result in damage to or destruction of property and/ or serious injury to or possible death of a person. The user of such information assumes all risk connected with the use thereof.

ISCO Industries, Inc. assumes no responsibility for the use of information presented herein and hereby disclaims all liability in regard to such use.

FUSION EQUIPMENT SAFETY INFORMATION



ISCO  **McELROY**

Safety Alerts

You will see these hazard alert icons appear in this manual.



HAZARD

When you see this sign, carefully read what it says.
YOUR SAFETY IS AT STAKE.



DANGER

This sign indicates an imminently hazardous situation which, if not avoided, can result in possible death or serious injury.



WARNING

This sign indicates a potentially hazardous situation which, if not avoided, could result in possible death or serious injury.



CAUTION

This sign indicates a hazardous situation which, if not avoided, may result in minor or moderate injury.

In this manual you should look for two other words:
NOTICE and **IMPORTANT**.

NOTICE

This can keep you from doing something that might damage the machine or someone's property. It may also be used to alert against unsafe practices.

IMPORTANT

This can help you do a better job or make your job easier in some way.

Read and Understand

Do not operate fusion equipment until you have carefully read, and understand the “Safety” and “Operation” sections of this manual, and all other equipment manuals that will be used with it.



Your safety and the safety of others depends upon care and judgement in the operation of this equipment.

Follow all applicable federal, state, local, and industry specific regulations.

ISCO Industries, Inc. cannot anticipate every possible circumstance that may involve a potential hazard. The warnings in this manual and on the machine are therefore not all inclusive. You must satisfy yourself that a procedure, tool, work method, or operating technique is safe for you and others. You should also ensure that the machine will not be damaged or made unsafe by the method of operation or maintenance you choose.

General Safety

Safety is important. Report anything unusual that you notice during set up or operation.

LISTEN for thumps, bumps, rattles, squeals, air leaks, or unusual sounds.

SMELL odors like burning insulation, hot metal, burning rubber, hot oil, or natural gas.

SENSE any changes in the way the equipment operates.

SEE problems with wiring and cables, hydraulic connections, or other equipment.

REPORT anything you see, feel, smell, or hear that is different from what you expect, or that you think may be unsafe.

Wear Safety Equipment

Wear a hard hat, safety shoes, safety glasses, and other applicable personal protection equipment.

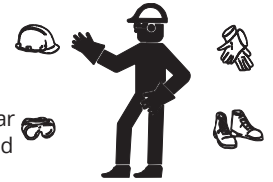

Remove jewelry and rings, and do not wear loose-fitting clothing or long hair that could catch on controls or moving machinery.

Units with Hydraulics

Although the hydraulic pressures in the machine are low compared to some hydraulically operated equipment, it is important to remember that a sudden hydraulic leak can cause serious injury or even be fatal if the pressure is high enough.

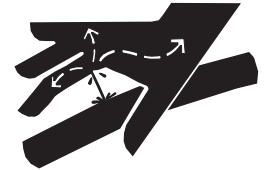

WARNING

Escaping fluid under pressure can penetrate the skin causing serious injury. Keep hands and body away from pinholes which eject fluid under pressure. Use a piece of cardboard or paper to search for leaks. If any fluid is injected into the skin, it must be immediately removed by a doctor familiar with this type of injury.

NOTICE

Wear safety glasses, and keep face clear of area when bleeding air from hydraulic system to avoid spraying into eyes.

Heaters Are Not Explosion Proof



DANGER

Heaters are not explosion proof. Operation of a heater in a hazardous environment without necessary safety precautions can result in explosion and possible death. When operating



in a hazardous environment, heater should be brought up to temperature in a safe environment, then unplugged before entering the hazardous atmosphere for fusion. Refer to the manufacturers Operators Manual for safe operating procedures.

Electric Motors Are Not Explosion Proof



DANGER

Electric Motors are not explosion proof. Operation of these components in a hazardous environment without necessary safety precautions can result in explosion



or possible death. When operating in a hazardous environment, keep pump motor and chassis in a safe area by using hydraulic extension hoses. Refer to the manufacturers Operators Manual for safe operating procedures.

Facer Blades Are Sharp



WARNING

Facer blades are sharp and can cut. Never attempt to remove shavings while the facer is running, or is in the facing position between the jaws. Use care



when operating the facer, and handling the unit.

NOTICE

Disconnect power from the facer, and remove the facer blades before attempting any maintenance or adjustment.

Crush Points



WARNING

Hydraulically operated jaws are operated under pressure. Anything caught in the jaws will be crushed. Keep fingers, feet, arms, legs, and head out of the jaw area. Always check pipe alignment with a pencil or similar object.



Electrical Safety



WARNING

Always ensure power cords are properly grounded. It is important to remember that when you are working in a wet environment with electrical devices, proper ground connections help to minimize the chances of an electric shock.



Frequently inspect electrical cords and unit for damage. Damaged components need to be replaced and service performed by a qualified electrician. Do not carry electrical devices by the cord.

NOTICE

Always connect units to the proper power source as listed on the unit, or in the owner's manual. On units with two power cords, plug each cord into separate power circuits. Do not plug into both outlets of one duplex receptacle. Notice: Disconnect the machine from the power source before attempting any maintenance or adjustment.



Heater Is Hot



CAUTION

The heater is hot and will burn clothing and skin. Keep the heater in its insulated heater stand or sling blanket when not in use, and use care when heating the pipe.



NOTICE

Use only a clean, dry, lint-free, non-synthetic cloth such as a cotton cloth to clean the heater plates.

Fusion Procedures



CAUTION

Follow the procedures carefully, and adhere to all specified parameters. Failure to follow procedures could result in an unacceptable weld. Always follow the proper fusion procedures.



Units with Gas Engines



WARNING

Handle fuel with care. Fuel is highly flammable. Do not refuel the machine while smoking or near open flames or sparks. Always stop the engine before refueling machine. Fill fuel tank outdoors. Help prevent fires by keeping machine clean of accumulated trash, grease, debris, and facer shavings. Always clean up spilled fuel.



Breathing exhaust gases can cause sickness or possible death. Always operate machine outdoors in an area with adequate ventilation.



Units with Batteries



CAUTION

Sulfuric acid in battery electrolyte is poisonous. It is strong enough to burn skin, eat holes in clothing, and cause blindness if splashed into eyes. Avoid contact with eyes, skin, and clothing. Exploding gases from the battery could cause blindness or serious injury. Keep sparks, flames and cigarettes away.



Have Tires Properly Serviced



WARNING

Failure to follow proper procedures when mounting a tire on a wheel or rim can produce an explosion which may result in serious injury or possible death. Have tires mounted by someone that is experienced, and has the equipment to perform the job safely.



Periodically Check Temperature

NOTICE

Incorrect heating temperature can result in unacceptable fusion joints. Check heater plate surface temperature periodically with a pyrometer, and make necessary adjustments. The thermometer on heaters indicates internal temperature, and should be used as a reference only.

Do Not Tow Fusion Machine at Speeds Greater Than 5 MPH



WARNING

The chassis is not designed for over-road towing. Towing at speeds greater than five miles per hour can result in machine damage as well as injury. Always transport the machine by flatbed truck or similar means, and make sure that unit is properly secured.

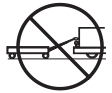

Positioning the Fusion Machine

Place fusion machine on as level ground as possible. If it is necessary to operate machine on un-level grade, chock the tracks and block the unit to make it as stable as possible.

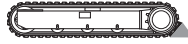

Keep Machine Away From Edge of Ditch



WARNING

Heavy equipment too close to a ditch can cause the walls of the ditch to cave in. Keep the machine far enough away from the edge of the ditch to prevent injury to personnel and equipment from a cave-in.

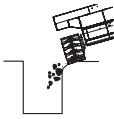

Operating TracStar Fusion Machines

Place fusion machine on as level ground as possible. If it is necessary to operate machine on un-level grade, make sure that the ground is stable. Some unstable conditions may be ice, snow, mud, and loose gravel.

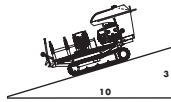

WARNING

For operation safety, never operate machine on a grade steeper than 30%. (A 3-foot elevation change in 10 feet.)

Do Not Attempt to Tow a TracStar Fusion Machine



CAUTION

The machine is not designed for towing. Attempting to tow the machine can result in machine damage. Always transport the machine by flatbed truck or similar means, and make sure that unit is properly secured.



Hearing Protection Required For TracStar 412 and TracStar 618

When operating machine for more than four hours per day, wear hearing protection.



Safety Precautions for Guarding Against Static Electricity and Gaseous Ignition



DANGER

Polyethylene plastic pipe does not readily conduct electricity. A static electricity charge can buildup on inside and outside surfaces and stay on the pipe surface until some grounding device, such as a tool or a person comes close enough for the static electricity to discharge to the grounding device.



WARNING

Discharging one part of the pipe surface will not affect other charged areas because static electricity does not flow readily from one area to another. Polyethylene pipe cannot be discharged by attaching grounding wires to the pipe.

Heaters, electric facers and electric power tools are NOT explosion-proof. Static electricity discharge can ignite a flammable gas or combustible dust atmosphere.

A static electricity discharge to a person, a tool, or a grounded object close to the pipe surface can cause an electric shock or a spark that can ignite a flammable gas or combustible dust atmosphere causing fire or explosion.

Safety Precautions for Guarding Against Static Electricity and Gaseous Ignition (Continued)



WARNING

In gas utility applications, static electricity can be a potential safety hazard. Where a flammable gas-air mixture may be encountered and static charges may be present, such as when repairing a leak, squeezing-off an open pipe, purging, making a connection, etc., arc preventing safety precautions are necessary. Observe all procedures for static electricity safety and control, including procedures for discharging static electricity and requirements for personal protection.

Take steps to discharge static electricity from the surface of the polyethylene gas pipe. Such steps include wetting the entire exposed pipe surface with a conductive anti-static liquid or a dilute soap and water solution, then covering or wrapping the entire wetted, exposed pipe surface with grounded wet burlap, conductive poly film, or wet tape conductor. The external covering should be kept wet by occasional re-wetting with anti-static solution. The covering or tape should be suitably grounded such as to a metal pin driven into the ground.

Steps that discharge the outer surface do not discharge the inner surface of the pipe. Squeeze-off purging, venting, cutting, etc., can still result in a static electricity discharge. When appropriate, ground tools and remove all potential sources of ignition.

TIPS:

- **DO NOT** put a butt fusion machine chassis in a hazardous environment. Set the chassis up in a safe area and use extension hoses to operate upper works in hazardous area.
- **DO NOT** use a butt fusion machine with an electric facer in a gaseous environment. Use a machine equipped with a hydraulic facer or convert the electric facer to a manual by removing the brushes and turning facer manually (see pages 23-24).
- When making butt fusions, saddle fusions and socket fusions in a hazardous environment, set up generator in safe area and have the heater plugged into it there. Set the heater temperature at the maximum allowed for the application. Use 450° F for butt fusion and 510° F for saddle fusion and socket fusion. These are heater surface temperatures. The maximum recommended temperatures are used to compensate for the drop in temperature experienced when heater is unplugged from the power source to make fusion in hazardous area. Unplug heater prior to using in a hazardous environment.
- **DO NOT** drill hole first prior to making a saddle fusion.
- When prepping the main pipe for a saddle fusion, do not use an electric grinding tool. Prepare main pipe manually by use of 50-60 grit utility cloth.
- **DO NOT** use an electric drill for punching hole through after saddle fusion has been made.
- Use your senses and good judgment: **LISTEN, SMELL, FEEL, SEE and REPORT** any unsafe situations you see or anticipate to your onsite contact. If corrective action is not adequate in your opinion, **DO NOT** enter into the situation.

TIPS FOR SUCCESS



TIPS:

- Use Personal Safety Equipment. Always wear a hard hat and protective boots. Gloves protect hands from heater burns and sharp blades on the facer. Always wear protective eye glasses.
- Make sure all equipment is in good working order and power cords are free of cuts with grounding prong on plug intact.
- Position fusion equipment on level ground whenever possible. If the fusion equipment has wheels, set the wheel lock or block them.
- For people new to HDPE fusion and looking to be qualified as a fusion operator, ASTM F3190, "Standard Practice for Heat Fusion Equipment (HFE) Operator Qualification on Polyethylene (PE) and Polyamide (PA) Pipe and Fittings" can provide guidance. ISCO's customer training conforms to ASTM F3190.
- Position pipe support stands on either side of the fusion equipment approximately 20 feet from ends of the fusion equipment. Adjust stands so that pipes are level to reduce drag.
- When working with McElroy Self-Contained fusion units excluding the T-500, T-630, T-900, and T-1200 make sure to open the facer valve prior to starting the unit and keep it open until started. Close facer valve once unit is running. This will save the battery and keep you from burning up the starter.
- Plug heater in on self-contained fusion units only after unit has been started and warmed up. Unplug heater before turning fusion unit off. This will keep you from having heater element and circuitry problems with your heater.
- Load loose pipe joints into movable side of the fusion equipment and pull joints already fused through non-movable side.
- Inspect pipe before you fuse it. Look for deep scratches, cuts and gouges. Use the 10 percent rule: Remove any section with damage affecting more than 10 percent of the pipe wall.
- When making fusions that involve pipe to fittings, attention should be given to the necking down or toe-in at the pipe ends, which is normal. This is observed primarily in working with larger pipe diameters and thinner wall pipe. Trimming up to two inches off of the length of the pipe helps correct the situation.

Tips for Success Continued

- When rough cutting pipe, use a pipe wrap to mark the pipe with a reference line, to aid you in making a square and even cut. In general, tooling that works with wood works well with HDPE pipe, including jig saws, skill saws and chain saws. When using chain saws, the cut ends MUST be cleaned with isopropyl alcohol to remove bar oil splash or any other contaminants. (Some choose to operate a chainsaw dry with no bar oil.) For cutting holes in pipe, drills with hole saws and reciprocating saws work well.
- Do not abuse the facer when facing pipes by using excessive pressure.
- When pulling pipe through the fusion equipment, elevate pipe in the machine using the pipe lifts so the fusion bead clears all obstructions as it is pulled through.
- If a fusion weld does not come out exactly as you like or you question the quality of the fusion weld, then cut it out and re-fuse. Always remember – **IF IN DOUBT, CUT IT OUT** and weld again.
- Fusion beads can be removed by means of external and internal bead removal tools without affecting the integrity of the fusion joint.
- In inclement weather and especially in windy conditions, the fusion operation should be shielded to avoid precipitation or blowing snow and excessive heat loss from wind chill. Capping ends of pipe that are being fused k heater from being chilled as fusion joint is being made.
- The joint area and any surfaces that are being fused must be completely dry. No liquid of any kind running through the pipe or fittings is permissible.
- When fusion is done in cold weather, **DO NOT INCREASE HEATING TOOL SURFACE TEMPERATURE.**
- Do not try to shorten cooling times of fusions by applying wet cloths, water or equivalent.

Tips for Success Continued

- When removing pipe from the fusion unit and pulling into place, use proper lifting slings and pulling heads in good condition. Chains and rope can slip and cause injury/damage to personnel and pipe.

When working with coiled pipe 2" - 6", a McElroy Line Tamer™ should be used to straighten and re-round coiled pipe to meet ASTM D2513 Quality Requirements.
- Squeeze tools can be used on HDPE Pipe to stop flow in a pipeline while a tie in or repair is made. Follow manufacturer's squeeze-off tool instructions.
- A common obstacle when working with HDPE pipe in the field is understanding the thermal expansion and contraction. Rule of thumb - 1.0"/ 100'/ 10°F. This means that HDPE will expand or contract approximately one inch for 100' of pipe for each 10°F change in temperature.

Butt Fusion Joining Rates

Pipe Sizes (IPS/DIPS)	Approx. Fusions (8-10hrs/day)
3/4" - 3"	30 - 60
4" - 8"	24 - 48
10" - 18"	12 - 24
20" - 24"	10 - 16
26" - 34"	8 - 12
36" - 48"	6 - 10
51.5" - 63"	4 - 8

IMPORTANT

Fusions per day are dependent upon pipe wall thickness, equipment to move and handle pipe, manpower, site conditions and weather. Use lower number for estimation and planning.

M McELROY

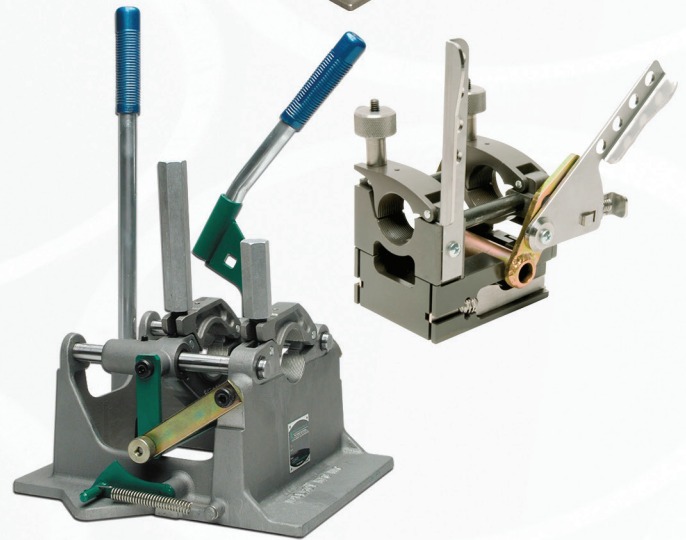

■ MANUAL BUTT FUSION MACHINE PROCEDURE

Manual Butt Fusion Machine Procedure

The theory of heat fusion is to heat two surfaces to a designated temperature, creating a melt zone, and then fuse them together by application of force. This pressure enables flow of the melted materials, resulting in mixing and entanglement of long-chain molecules, and thus fusion. When the polyethylene material is heated, the molecular structure is transformed from a crystalline state into an amorphous condition. When fusion pressure is applied, the molecules from each polyethylene part mix. As the joint cools, the molecules return to their crystalline form, the original interfaces are gone, and the two pipes become one homogeneous unit. A strong, fully leak-tight connection is the result.

The principle operations include:

- Clamping:** The pipe pieces held axially to allow all subsequent operations to take place. Place the pipe into the machine with the long axis up and down.
- Facing:** The pipe ends must be faced to establish clean, parallel mating surfaces perpendicular to the centerline of the pipes and to remove surface oxidation of material. Face the piping component ends until the facer bottoms out on the stops and is locked between the jaws.
- Alignment:** The pipe ends must be aligned with each other to minimize mismatch or high-low of the pipe wall.
- Heating:** A melt pattern that penetrates into the pipe must be formed around both pipe ends.
- Joining:** The melt patterns must be joined with a specified force. The force must be constant around the interface area.
- Holding:** The molten joint must be held immobile with a specified force until adequately cooled.



Butt Fusion of Pipes and Components With Different Wall Thicknesses

According to ASTM F2620, section X1.4 of Appendix X1 addresses, "butt fusion joining of pipes and fittings that have the same outside diameter but unlike wall thickness (different by one standard DR or more) is possible." ISCO recommends following accepted industry practice that the wall thickness difference should not exceed 26% in order to maintain the pressure rating of the lowest rated component (the thinner of the two-wall thickness) involved in the butt fusion. Wall thickness differences in excess of this recommendation may induce a stress riser that could affect the quality of fusion joint to withstand events like pressure surges and external loading that may not affect welds with the same wall thickness.

Example: Pipe or fittings that have a wall thickness of 1" would be welded to a pipe or fitting with a wall thickness of .74" or 1.35" to maintain full pressure rating.

CONSIDER:

- The pipe line is only as strong as its weakest link or lowest rated component.
- Beveling or counter-boring the thicker wall can help reduce or eliminate the difference in wall thickness.
- The fusion pressure used to join two different wall thicknesses is always that of the thinner wall pipe/component.

**See chart on page 37 for more information.*

Install Clamping Inserts

Select and install appropriate clamping inserts for the pipe that is being fused.

No. 1LC & Mini-Mc® Machines

(1/2" CTS - 1" IPS Pipe)

1" CTS and smaller inserts are fitted to jaw castings using flat head fasteners.



No. 2LC & No. 2CU Machines

(1/2" CTS - 2" IPS Pipe)

1-1/2" and smaller inserts are fitted to jaw castings using flat head fasteners.

No. 14 Pitbull Machines

(1" IPS - 4" DIPS Pipe)

2" Master, 3", and 4" inserts are held in place by spring pins located on upper and lower jaws. 1-1/2" and smaller inserts are fitted to 2" IPS Master inserts using flat head fasteners.

No. 26 Pitbull Machines

(2" IPS - 6" DIPS Pipe)

2", 3", and 4" inserts are held in place by spring pins located on upper and lower jaws.

Cleaning the Pipe

Before installing the pipe in the fusion machine, clean the OD, ID and ends with a clean, dry, lint-free non-synthetic cloth such as cotton. If the contamination cannot be removed this way, wash the pipe with water and a clean cloth or paper towel to remove the contamination.



If contamination, such as bar oil, was transferred to the pipe ends after cutting, use 90% or greater isopropyl alcohol on a clean cloth or isopropyl wipes on the ends of the pipe to clean the contamination. Plastic bristle scrub brushes can be used when necessary. Do not use soap or cleaning solvents.

Loading Pipe into Machine

No.14 Pitbull used in the following Illustrations

Step One

Clean the inside and outside of the pipe ends that are to be fused.

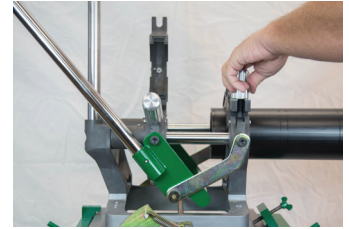

Step Two

Open the upper jaws and insert pipe in each pair of jaws with applicable inserts installed with the long axis of pipe OD vertically up and down.

Step Three

Let the ends of the pipe protrude about 1" past the face of the jaws. Close upper jaws but do not overtighten.

Electric Facer

The facer is a McElroy Rotating Planer Block Design. The blade holders each contain two cutter blades. The Block rotates on ball bearings and is chain driven (enclosed in lubricant) by a heavy-duty electric motor. When operating in a hazardous environment, operate the facer manually.



DANGER

Electric motors are not explosion proof. Operation of these components in a hazardous environment can result in explosion and possible death.

Continued on next page

Electric Facer

The armature brushes must be removed from the electric motor when manually operating in a hazardous condition (see middle picture). Unscrew the brush covers from both sides of the motor. (Both brushes must be removed). A 7/8" hex shaft allows for manual operation in hazardous conditions (see top picture).

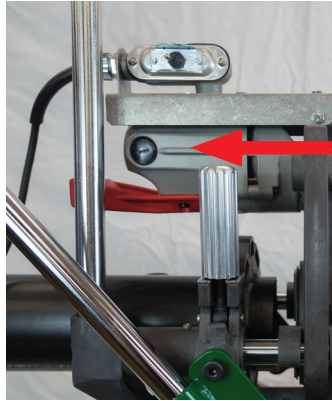

The facer has a handle that latches into place on a guide rod. The handle must be pulled out to unlatch and remove facer.



Manual Facer for No. 2LC and No. 2CU

The manually operated facer will need to be hand cranked. Turn the crank counterclockwise for facing.

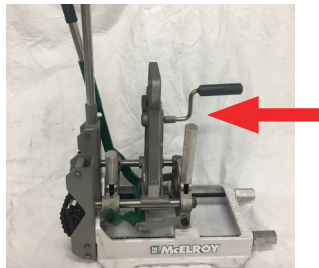

Cam Lock

A semi-automatic cam locking system locks the movable jaw during the cooling cycle.

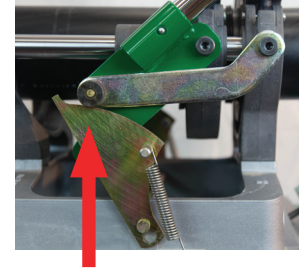

Inserting Facer

Place the end opposite the locking handle onto the far guide rod, then lower the facer locking handle end down onto the near guide rod and latch.



Positioning Pipe in Machine

REMINDER

Ensure all dirt and debris is removed from pipe ends before facing.

Step One

With facer in position use lever handle to bring pipe ends together against the facer, watching the gap between the facer stops and the pipe clamping jaws. Leave enough gap so that proper face-off will be achieved when the facer stops are bottomed out against the clamps.

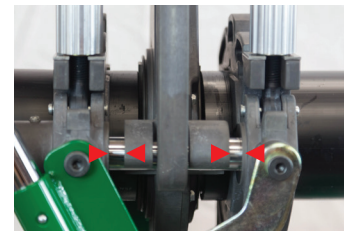

Step Two

Tighten the pipe clamp knobs by hand until firm resistance is felt. DO NOT over-tighten.

Facing the Pipe with Manual Facer

Step One

Turn facer handle counterclockwise and apply firm pressure on lever handle. Continue facing until facer stops have bottomed out against the clamping jaws. Stop rotation of facer. Move jaws apart.

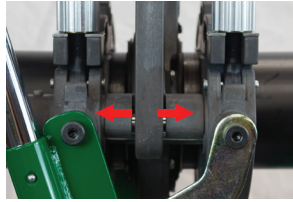

Step Two

Unlatch and remove facer. Make sure shavings are clear of the fusion zone. **DO NOT** touch faced pipe ends.

Step Three

Inspect both pipe ends for complete face off. If the face off is incomplete, return to Loading Pipe into Machine on page 23.

Electric Facer

Step One

The electric facer should be started before the pipe is pushed into contact with the blades.

Step Two

Continue facing until the facer stops are against the jaws.

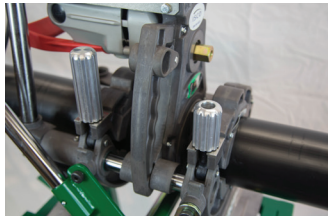

Step Three

Turn off the facer while continuing to hold pressure closed on the lever until the facer stops completely. Reverse force to the lever handle to move the pipe ends away from the facer.

Step Four

Unlatch and remove the facer taking care not to touch the pipe ends.

Step Five

Remove shavings from pipe ends and machine. Make sure shavings are clear of the fusion zone. **DO NOT** touch faced pipe ends as this may contaminate them.

Step Six

If faced pipe ends are touched, use a clean, dry, lint-free, non-synthetic cloth such as cotton to clean affected area before proceeding.

Step Seven

If after facing, any imperfections are visible, return to Loading Pipe into Machine on **page 23**. Any time clamp knobs are tightened, pipe ends should be refaced.

Check Alignment of Pipe

Step One

Bring the pipe ends together under sufficient force to overcome any pipe drag or friction in the system.

Step Two

Check for alignment and proper face off. If high/low (misalignment) exists, adjust by tightening the clamp on the high side and reface the pipes. There should be no more than 10% of the wall thickness in misalignment to maintain full joint strength.

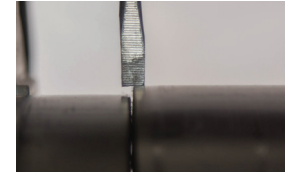

Mis-aligned

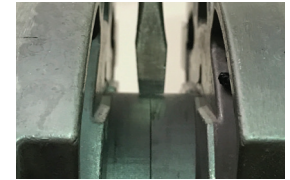

Aligned

NOTICE

When clamping, do not over-tighten the clamp knobs because machine damage can result. Check to see if there is space between the upper and lower jaws. If the two jaws are touching, do not continue to tighten. Bring the pipe ends together under fusion pressure to check for slippage. If slippage occurs, return to Loading Pipe into Machine section on **page 23**.

Check Heater Temperature



CAUTION

Incorrect heating temperature can result in questionable fusion joints. Check heater plates periodically in multiple locations with a pyrometer and make necessary adjustments.

For butt fusion heater surface temperature should be Minimum 400° F, **Optimum 425° F**, Maximum 450° F.



IMPORTANT

The dial thermometer on the heater indicates **internal** temperature which varies from the actual surface temperature. The dial thermometer shall be considered reference only.



The dial thermometer should be used as reference only once the surface temperature has been verified.

Inserting Heater



DANGER

Heater Is Not Explosion Proof. **Operation of heater in a hazardous**

environment without necessary safety precautions can result in explosion and possible death.

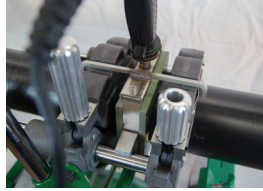

If operating in a hazardous environment, heater should be brought up to temperature in a safe environment, then unplugged before entering the hazardous atmosphere for fusion.

Use a clean, dry, lint-free non-synthetic cloth, such as cotton, to clean butt fusion heater adapter surfaces.

Step One

Check heater adapters for coating damage, plastic buildup rings and surface imperfections. These conditions could cause a poor fusion. Replace them if conditions exist.

Step Two

Verify heater temperature by referencing the reading on the dial thermometer. Insert heater between the pipe ends. The downward legs of the stripper bar should be outside of the jaws (not on top).

Heating the Pipe

Step One

With heater in position between the pipe ends, bring the pipe or fitting ends into full contact with the heater to ensure proper seating. Raise the Cam Lock into the engaged position while in the heating cycle.



Step Two

Maintain contact, without force, while a bead of molten polyethylene develops between the heater and the pipe or fitting ends. Continue heating the pipe ends until the minimum melt bead size has developed.

Minimum Melt Bead Size:

Pipe (OD), in.	Minimum Bead Size in.
Below 2.37"	1/32"
2.375" to 3.50"	1/16"
3.51" to 8.625"	3/16"

DO NOT HEAT UNDER PRESSURE.

Fusing the Pipe & Max. Heater Plate Removal Times

Step One

Once melt beads are of proper size, remove the heater, **QUICKLY** inspect the melted ends, which should be flat, smooth, and completely melted.

Step Two

If the melted surfaces are acceptable and in a continuous motion, bring the ends together and apply enough joining force for the beads to touch, and form a double roll back against the pipe wall.

DO NOT slam.

A concave melt surface is unacceptable; it indicates pressure during heating. **DO NOT** continue. Allow the melted ends to cool and start over (**see page 22**).

The locking cams will assist by holding force during the cooling cycle.

Maximum Heater Plate Removal Times:

Pipe Wall Thickness, (inches)	Max Heater Plate Removal Times (seconds)
0.17" to 0.36"	8
> 0.36" to 0.55"	10
> 0.55" to 1.18"	15

Unacceptable Concave Melt Appearance

What Causes This?

Answer: Heating under pressure.

NOTICE

A concave melt surface has a raised edge on the inside and outside diameter of the heated pipe end.

Concave melt appearance is unacceptable and indicates pressure during heating. Do not continue. Allow the melted ends to cool, then start the process again (**see page 26**).



Concave - Incorrect



Flat - Correct

Optional Use of Torque Wrench

After the heating cycle is completed, remove the heater and quickly apply fusion pressure with the lever handle. To use a torque wrench with the No. 14 and No. 26 PitBull, place an adapter in the lever socket.

A 15" torque wrench is required when using the torque wrench adapter. The locking cams will assist by holding force during the cooling cycle.

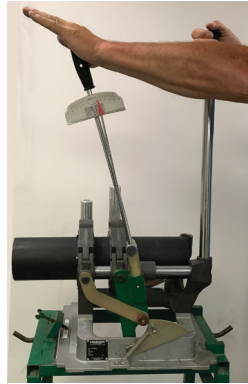

Torque Wrench Adapter (left)
Part number: **410802**



CAUTION

Failure to follow the proper heating time, pressure and cooling time may result in an unacceptable joint.

Torque (Ft. Lb.)	Jaw Axial Force (Lb.)		
	No. 2LC	No. 14 PitBull	No. 26 PutBull
10	70	115	115
20	135	215	215
30	200	330	330
40	260	435	435
50	320	545	545
60	400	660	660
70	480	780	780
80	550	915	915
90	635	1025	1025
100	690	1140	1140

Interfacial Pressure (IFP)

Minimum 60 psi
Optimum 75 psi
Maximum 90 psi

To determine the amount of force required:

$(OD-t) \times t \times 3.1416 \times (IFP)$
 $75 + DRAG = \text{Force}$

$\text{Force} = ((OD-t) \times t \times \pi \times IFP) + DRAG$
Where $\pi = 3.1416$

This value is then read on chart to determine how to apply the force.

DRAG = Amount of force required to move pipe; measured by torque wrench.

Cooling Of the Fusion Joint

Hold the molten joint immobile under fusion pressure until sufficiently cooled. Cooling under pressure before removal from the butt fusion machine is important in achieving joint integrity. Maintain fusion pressure against the piping component ends for a minimum of 11 minutes per inch of pipe wall thickness. Avoid high stress such as pulling, installation or rough handling for additional 30 min or more after removal from fusion machine.

Minimum Cooling Time (In Minutes):

IPS OD	DR	MCT
2	7	3:45
2	9	3:00
3	7	5:30
3	9	4:30
4	7	7:15
4	9	5:30
4	11	4:30
4	17	3:00
6	7	10:30
6	9	8:15
6	11	6:45
6	17	4:30
8	7	13:45
8	9	10:45
8	11	8:45
8	17	5:45

Remove Pipe and Inspect

Step One

After pipe has cooled sufficiently, apply closing force on the lever handle and push the locking cams down into the unlocked position.

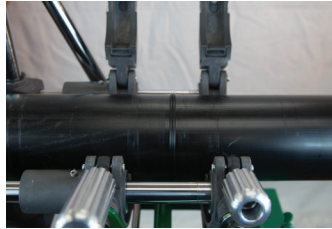

Step Two

Unscrew the clamp knobs enough that they can be swiveled outward. Pull pipe through machine, and prepare for making next fusion. Inspect joint and if it has to be redone, use Trouble Shooting Guides to determine problem and make the proper adjustments before next fusion. (See **page 33**)

The Inspection of the Fusion Joint

GOLDEN RULE

If in doubt, cut it out and start over.

The double bead should be rolled over onto the adjacent surfaces, and be uniformly rounded and consistent in size all around the joint. As illustrated in the Figure below, all beads will not necessarily have equal size. The cleavage between the beads must not be lower than the wall of the pipe as shown in the lower center illustration.

It is not necessary for the internal bead to roll over to the inside surface of the pipe.

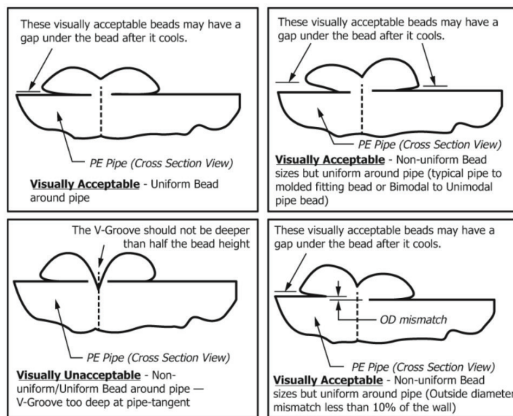

FIG. 5 Outside Diameter Butt Fusion Bead Guideline

The Inspection of the Fusion Joint

ASTM F2620-20ae2 also has the following notes for review of butt fusions:

NOTE 11: When butt fusing to molded fittings, the fitting-side bead may display shape irregularities such as minor indentations, deflections, ripples, non-uniform bead rollover from molded part cooling and knit lines, and other surface effects. In such cases, visual evaluation is based mainly on the size and shape of the pipe-side bead.

NOTE 12: For butt fusions between compatible polyethylene materials having different polymer characteristics (that is, unimodal to bimodal, high density to medium density, pipe to fitting, etc.) the fusion bead may be visually different on either side of the joint. These differences do not affect the integrity of the fused joint.

NOTE 13: ASTM F2620 Appendix X2 provides examples of unacceptable fusion joint appearances.

Butt Fusion Joint Troubleshooting Guide

Observed Condition	Possible Cause
Double bead v-groove too deep	Excessive joining force; Insufficient heating; Pressure during heating
Flat top on bead	Misalignment; Defective heating tool; Worn equipment; Incomplete facing
Beads too small	Insufficient heating; Insufficient joining force
Squarish outer bead edge	Pressure during heating
Rough, sandpaper-like, bubbly, or pockmarked melt bead surface	Hydrocarbon contamination
Third Bead	Excessive joining force



Cross section view of butt fusion melt pattern with bead.



■ HYDRAULIC BUTT FUSION MACHINE PROCEDURE

Hydraulic Butt Fusion Machine Procedure

The theory of heat fusion is to heat two surfaces to a designated temperature, creating a melt zone, and then fuse them together by application of force. This pressure enables flow of the melted materials, resulting in mixing and entanglement of long-chain molecules, and thus fusion. When the polyethylene material is heated, the molecular structure is transformed from a crystalline state into an amorphous condition. When fusion pressure is applied, the molecules from each polyethylene part mix. As the joint cools, the molecules return to their crystalline form, the original interfaces are gone, and the two pipes become one homogeneous unit. A strong, fully leak-tight connection is the result.

The principle operations include:

Clamping: The pipe pieces held axially to allow all subsequent operations to take place. Place the pipe into the machine with the long axis up and down.

Facing: The pipe ends must be faced to establish clean, parallel mating surfaces perpendicular to the centerline of the pipes and to remove surface oxidation of material. Per ASTM you must face the pipes until the facer bottoms out on the stops.

Alignment: The pipe ends must be aligned with each other to minimize mismatch or high-low of the pipe wall.

Heating: A melt pattern that penetrates into the pipe must be formed around both pipe ends.

Joining: The melt patterns must be joined with a specified force. The force must be constant around the interface area.

Holding: The molten joint must be held immobile with a specified force until adequately cooled.

Butt Fusion of Pipes and Components With Different Wall Thicknesses

According to ASTM F2620, section X1.4 of Appendix X1 addresses, "butt fusion joining of pipes and fittings that have the same outside diameter but unlike wall thickness (different by one standard DR or more) is possible." ISCO recommends following accepted industry practice that the wall thickness difference should not exceed 26% in order to maintain the pressure rating of the lowest rated component (the thinner of the two-wall thickness) involved in the butt fusion. Wall thickness differences in excess of this recommendation may induce a stress riser that could affect the quality of fusion joint to withstand events like pressure surges and external loading that may not affect welds with the same wall thickness.

Example: Pipe or fittings that have a wall thickness of 1" would be welded to a pipe or fitting with a wall thickness of .74" or 1.35" to maintain full pressure rating.

CONSIDER:

- The pipe line is only as strong as its weakest link or lowest rated component
- Beveling or counter-boring the thicker wall can help reduce or eliminate the difference in wall thickness
- The fusion pressure used to join two different wall thicknesses is always that of the thinner wall pipe/component.

Range of PE Wall Thickness Fusion Compatibility			
Pipe or Fitting DR	Can be fused to a pipe or fitting with a		
	Min DR of	or	Max DR of
7	5.5		9
9	7		11
11	9		13.5
13.5	11		17
17	13.5		21
21	17		26
26	21		32.5
32.5	26		41

Hydraulic Manifold Block

Mounted on this block are a carriage directional control valve, a selector valve, three pressure reducing valves, and a pressure gauge.



- A) The carriage control valve, mounted on the top of the manifold, determines whether the carriage is moving left, right, or in neutral.
- B) A pressure gauge is mounted on top of the manifold.
- C) The selector valve, mounted on the front of the manifold, selects a pressure from one of the pressure reducing valves (D-F). Each pressure reducing valve is labeled with a different function.
- D) The top valve adjusts facing pressure, normally 50-100 psi gauge pressure.
- E) The middle valve adjusts heating pressure, always 0 psi/drag or backed all the way out, turning knob counterclockwise. The drag pressure may have to be compensated for when working with heavy wall pipe or more than one joint of pipe on the movable side or with tie-ins.
- NOTE**
Example of heavy wall pipe is (14" and up; DR 13.5 and thicker)
- F) The bottom valve adjusts fusion pressure, this pressure must be determined (pages 39-41).

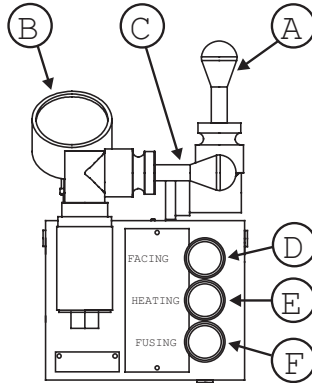

Installing Clamping Inserts

Select and install appropriate clamping inserts for the pipe that is being fused.



Check Hydraulic Pressure

The pressure gauge on the manifold block indicates the pressure of the carriage valve. How much pressure depends on the position of the selector valve and the pressure set on the specific pressure reducing valve. With the selector valve up, the facing pressure can be set. It may be necessary to adjust the carriage speed, while facing, with the top pressure-reducing valve to control facing speed.

Step One

Shift the selector valve to the center position, heating, and set the pressure reducing valve at its lowest setting, or the drag pressure, whichever is higher.

Step Two

With the selector valve in the down position, the fusion pressure can be set. The fusion pressure can be determined by:

- The reference section of this book (pages 96-105)
- McCalc Fusion Calculator App
- The Fusion Pressure Calculator (page 40)
- Using the formula on page 41

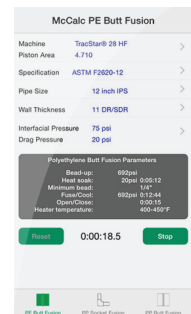

Step Three

An approximate 30 psi drag factor should compensate for seal, and pipe drag with one joint of pipe on a pipe stand. If additional lengths of pipe or heavy wall pipe are being moved by the movable jaws, **the actual drag pressure** should be determined using the following procedure:

- After facing the pipe, move the carriage so that the pipe ends are approximately 2" apart.

Continued on next page

Check Hydraulic Pressure Continued

- Shift the carriage control valve to the middle (neutral) position, select the heating mode, and adjust the middle pressure reducing valve to its lowest pressure by turning the valve counterclockwise.
- Shift the carriage control valve to the left.
- Gradually increase the pressure by turning the heating valve clockwise. Increase the pressure until the carriage moves.
- Quickly reduce the heating pressure valve counterclockwise until the carriage is just barely moving. Record this actual drag pressure.
- Take the calculated or reference fusion pressure and add the actual measured drag pressure. This will be the actual fusion pressure to set with the bottom pressure reducing valve. If fusion pressures are used from the reference section, you must subtract 30 psi drag, which is already figured in and then add the actual drag pressure back.
- Adjust the middle heating valve to show recorded drag so that pipe ends will stay in contact with heater during heating phase.

Fusion Pressure Calculator

Interfacial Pressure (IFP)

Minimum 60 psi
Optimum 75 psi
 Maximum 90 psi

Interfacial Pressure (IFP) = amount of force per sq. inch of the surface area of the pipe end.

Interfacial Pressure (IFP) and Fusion machine gauge pressure are not the same.

How to Use the Fusion Pressure Calculator

- Step 1: Set DR at Pipe Size.
- Step 2: Align McElroy Fusion Machine with IFP.
- Step 3: Read Gauge Pressure at red arrow.
- Step 4: Add Drag Pressure to gauge pressure.

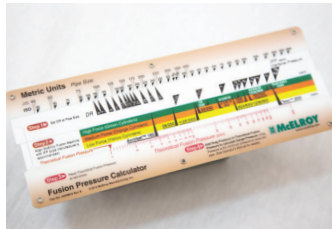

Determining Fusion Pressure

Variable Definitions

OD = Outside Diameter

t = Wall Thickness

Pi = 3.1416

DR = Dimensional Ratio

IFP = Recommended Interfacial Pressure (Shown on page 40)

TEPA = Total Effective Piston Area

DRAG = Force Required to Move Pipe

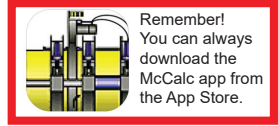

Example: Using a McElroy No. 28 Standard Fusion Machine (High Force, Green Cylinder)

Pipe Size = 8" IPS

OD of Pipe = 8.625

DR of Pipe = 11

Recommended Interfacial Pressure = 75 PSI

Measured Drag 30 PSI

Formula For Wall Thickness

$$t = \frac{OD}{DR} = \frac{8.625}{11} = .784$$

TEPA = 4.710 (chosen from the table below)

$$\text{Gauge Pressure} = \frac{(OD - t) \times t \times \pi \times \text{IFP}}{\text{TEPA}} = \text{DRAG}$$

$$\text{Gauge Pressure} = \frac{(8.625 - .784) \times .784 \times \pi \times 75}{4.710} = 30 \text{ PSI} = 338 \text{ PSI}$$

NOTICE

See Reference Section, **pages 100-109**, for fusion pressure charts showing pressures precalculated which include 30 psi for system drag.

TEPA = Total Effective Piston Area			
Fusion Machine Model	High Force Standard (Green Cylinders)	Medium Force High Velocity (Orange Cylinders)	Low Force Extra High Velocity (Yellow Cylinders)
28 or T-28	4.71	NA	1.66
412 or T-412	11.78	6.01	3.14
618 or T-618	11.78	6.01	3.14
T-500 Series I, II or 3	NA	6.01	NA
824 or T-630	29.44	15.32	9.45
1236 or T-900	29.44	15.32	9.45
1648 or T-1200	31.42	14.14	NA
2065 or 1600	31.42	14.14	NA

Cleaning the Pipe

Before installing the pipe in the fusion machine, clean the OD, ID and ends with a clean, dry, lint-free non-synthetic cloth such as cotton. If the contamination cannot be removed this way, wash the pipe with water and a clean cloth or paper towel to remove the contamination.



If contamination, such as bar oil, was transferred to the pipe ends after cutting, use 90% or greater isopropyl alcohol on a clean cloth or isopropyl wipes on the ends of the pipe to clean the contamination.

Loading Pipe into Machine

No.28 used in the following Illustrations.

Step One

Clean the inside and outside of pipe ends that are to be fused.

Step Two

Open the upper jaws and insert pipe in each pair of jaws with applicable inserts installed.



Step Three

Let the ends of the pipe protrude more than 1" (This distance changes with fusion machine type) past the face of the jaws.

Step Four

Tighten the clamp knobs on the outer jaws to prevent pipe slippage and lightly tighten inner clamp knobs for possible later alignment adjustments.

Facing the Pipe

Step One

Move the carriage to the right.

Step Two

Pivot the facer into place and secure.

Step Three

Open the ball valve on the facer motor.

Step Four

Assure the selector valve handle is up in the facing position.

Step Five

Move the carriage to the left. If the facer stalls, adjust the facing pressure so the facer continues to cut.

IMPORTANT:

When facing heavy wall pipe, it may be necessary to increase the facing pressure.

Step Six

Let the carriage bottom out at the facer stops. Turn the facer off. Move the carriage to the right so the facer can be removed.



Step Two



Step Three

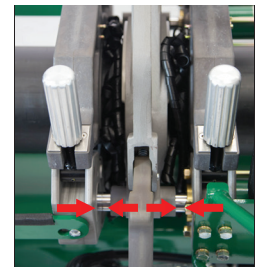

Step Six



WARNING: Facer blades are sharp and can cut or harm operators or individuals if they come into contact with cutting surface. Keep personnel clear of facer blades.

Remove Facer

Step One

Pivot the facer out and up to the storage position by disengaging the locked handle.

Step Two

Remove pipe shavings from lower side of pipe ends, careful not to touch faced pipe ends.

Step Three

If faced pipe ends are touched, use clean non-synthetic cloth to clean affected area before proceeding.

Step Four

Move the carriage to the left until ends of pipe butt together. Check pipe joint for proper alignment.



WARNING: DO NOT use finger to check for high/low (misalignment). The unit is under pressure, and slippage could result in crushed fingers. Always keep hands clear of the jaw area and all pinch points.

If pipe is not aligned, tighten the inner high side jaw to bring into alignment.

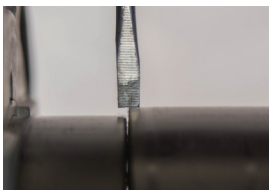

Mis-aligned

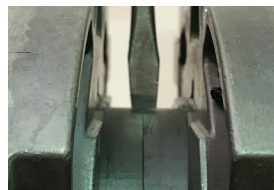

Aligned

IMPORTANT

Always tighten the side that is higher, never loosen the low side.

When the pipe is properly aligned tighten outside clamps to insure against slippage. If clamp knob adjustment has been made, reinstall facer and begin facing procedure again.

Continued on next page

(IMPORTANT Continued)

Let the carriage bottom out on facer stops. Turn facer off. Move the carriage to the right so the facer can be removed.

Remove shavings from pipe ends careful not to touch faced pipe ends. Bring the pipe ends together under fusion pressure to check for slippage. If slippage occurs, return to Loading Pipe into Machine on page 42.

NOTICE

There should be no more than 10% of the wall thickness in misalignment to maintain full joint strength.

Position Carriage for Heater Insertion

Move carriage to the right to open a gap large enough to insert the heater.

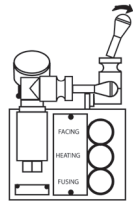

Check Heater Temperature



CAUTION

Incorrect heating temperature can result in questionable fusion joints. Check heater plates periodically in multiple locations on both sides of plates with a pyrometer and make necessary adjustments.

For butt fusion heater surface temperature should be Minimum 400° F, **Optimum 425° F**, Maximum 450° F.

IMPORTANT

The dial thermometer on the heater indicates internal temperature. The dial thermometer can be used as reference once the surface temperature has been verified.



Select the Fusion Position

Move selector valve handle down to the fusing position. Use fusion pressure required from step two/three on **page 39**.

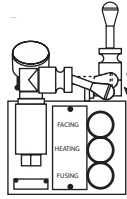

Inserting Heater



DANGER

Heater Is Not Explosion Proof. Operation of heater in a hazardous environment without necessary safety precautions can result in explosion and possible death.

Use a clean, dry, lint-free, non-synthetic cloth such as cotton to clean the butt fusion heater plate surfaces.

If operating in a hazardous environment, heater should be brought up to maximum recommended temperature in a safe environment, then unplugged before entering the hazardous atmosphere for fusion.

Check heater plates for coating damage, plastic buildup rings and surface imperfections. These conditions could cause a poor fusion. Replace them if conditions exist.

Verify heater temperature noting the reading on the dial thermometer per instructions on **page 45**.

Insert heater between the pipe ends.



Heating the Pipe

A) Move the carriage to the left under the fusion pressure, bringing the heater into full contact with both pipe ends, seating pipe ends against heater. Briefly ensure full contact between piping component ends and heating tool. Proceed to **Step B**. [On larger pipe sizes, (14in. and larger) maintain the fusion pressure until a slight melt is observed around the circumference of the pipe or fitting before proceeding to **Step B**.]

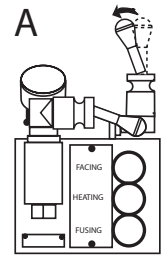

B) Move selector valve to center position, allowing the pressure to drop but maintaining contact without force. When fusing more than one pipe length on the movable side of the fusion unit, drag must be compensated for as described **pages 39-40**.

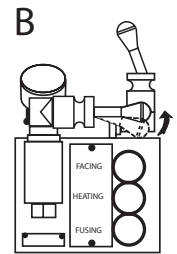

C) Return carriage control valve to neutral (middle) position. The pipe ends are now heating at "0" pressure or the pressure to compensate for drag, allowing the pipe ends to remain in full contact with the heater, while a bead of molten polyethylene develops between the heater and the pipe or fitting ends. For 14" IPS pipe sizes and larger, maintain the heat soak time for a minimum of 4.5 minutes for every inch (25.4mm) of pipe wall thickness. (see Minimum Heat Soak Time & Cooling Time Table **page 51**) After the minimum heat soak time for larger pipe sizes and for all other pipe sizes; verify the minimum bead size has been established, using the Minimum Melt Bead Size table (**page 48**) to determine the proper size.

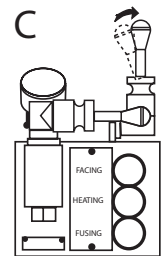

Minimum Melt Bead Size (needed before removing heater)

Pipe OD Outside (Nominal) Diameter, in.	Approximate Melt Bead Size
2" through 3"	1/16"
3" through 8"	3/16"
8" through 12"	1/4"
12" through 24"	3/8"
24" through 36"	7/16"
36" through 65"	9/16"

Fusing the Pipe



CAUTION

Failure to follow the proper shift sequence, verify proper melt appearance pattern and achieve proper cooling time may result in an unacceptable joint.

After proper melt pattern has been established, use the Approximate Melt Bead Size chart above to determine the proper size, then:

- Shift the selector valve down to fusion position.
- Move the carriage to the right just enough to remove the heater. The stripper bar on the heater should help "pop" heater loose. Quickly remove the heater without coming into contact with melted pipe ends.
- Quickly inspect pipe ends, which should be flat, smooth, and completely melted. Concave pipe ends are unacceptable, see below. If acceptable, shift carriage control valve to the left immediately bringing ends together and apply fusion pressure, calculated from step two/three on page 39.

NOTICE: Bring pipe ends together being careful not to exceed the Maximum Heater Plate Removal Time shown on next page.

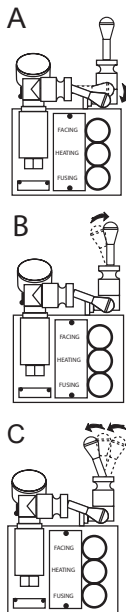

Maximum Heater Plate Removal Times

Pipe Wall Thickness, in.	Max. Heater Plate Removal Time
0.17 to 0.36	8 seconds
>0.36 to 0.55	10 seconds
>0.55 to 1.18	15 seconds
>1.18 to 2.5	20 seconds
>2.5 to 4.5	25 seconds

Unacceptable Concave Melt Appearance

What Causes This?

Answer - Heating under pressure.

NOTICE: A concave melt surface has a raised edge on the inside and outside diameter of the heated pipe end. Concave melt appearance is unacceptable and indicates pressure during heating. Do not continue. Allow the melted ends to cool, then start the process again (see top of page 42).



Concave - Incorrect



Flat - Correct

Cooling Of the Fusion Joint

The fusion joint must be kept under fusion pressure until joint has sufficiently cooled. Maintain fusion pressure against the piping component ends for a minimum of 11 minutes per inch of pipe wall. (See Minimum Heat Soak Time & Cooling Time Table below and to the right) Avoid high stress such as pulling, installation or rough handling for an additional 30 minutes or more after removal from the fusion machine.

Minimum Heat Soak Time & Cooling Time Table (in minutes) – DIPS Pipe

DIPS Size	DR	MHST	MCT	DIPS Size	DR	MHST	MCT	DIPS Size	DR	MHST	MCT
4	7	-	8	16	7	12	28	36	9	20	47
4	9	-	6	16	9	9	22	36	11	16	39
4	11	-	5	16	11	8	18	36	13.5	13	32
4	13.5	-	4	16	13.5	6	15	36	17	11	25
4	17	-	4	16	17	5	12	36	21	9	21
6	7	-	11	18	7	13	31	36	26	7	17
6	9	-	9	18	9	10	24	36	32.5	6	13
6	11	-	7	18	11	8	20	42	11	19	45
6	13.5	-	6	18	13.5	7	16	42	13.5	15	37
6	17	-	5	18	17	6	13	42	17	12	29
8	7	-	15	20	7	14	34	42	21	10	24
8	9	-	12	20	9	11	27	42	26	8	19
8	11	-	10	20	11	9	22	42	32.5	7	16
8	13.5	-	8	20	13.5	8	18	48	11	21	51
8	17	-	6	20	17	6	14	48	13.5	17	42
10	7	-	18	24	7	17	41	48	17	14	33
10	9	-	14	24	9	13	32	48	21	11	27
10	11	-	12	24	11	11	26	48	26	9	22
10	13.5	-	10	24	13.5	9	22	48	32.5	8	18
10	17	-	8	24	17	7	17	48	13.5	17	42
12	7	-	21	30	9	16	40	54	13.5	20	47
12	9	-	17	30	11	14	32	54	17	16	37
12	11	-	14	30	13.5	11	27	54	21	13	30
12	13.5	-	11	30	17	9	21	54	26	10	25
12	17	-	9	30	21	7	17	54	32.5	8	20
14	7	10	25					60	13.5	21	51
14	9	8	19					60	17	17	40
14	11	7	16					60	21	14	33
14	13.5	6	13					60	26	11	27
14	17	5	10					60	32.5	9	21

Maximum Heat Soak Time & Cooling Time Table (in minutes) – IPS Pipe

IPS Size	DR	MHST	MCT	IPS Size	DR	MHST	MCT	IPS Size	DR	MHST	MCT
2	7	-	4	18	7	12	29	34	9	17	42
2	9	-	3	18	9	9	22	34	11	14	34
3	7	-	6	18	11	8	18	34	13.5	12	28
3	9	-	5	18	13.5	6	15	34	17	9	22
4	7	-	8	18	17	5	12	34	21	8	18
4	9	-	6	20	7	13	32	36	9	18	44
4	11	-	5	20	9	10	25	36	11	15	36
4	13.5	-	4	20	11	9	20	36	13.5	12	30
4	17	-	3	20	13.5	7	17	36	17	10	24
6	7	-	11	20	17	6	13	36	21	8	19
6	9	-	9	22	7	15	35	36	26	7	16
6	11	-	7	22	9	11	27	36	32.5	5	13
6	13.5	-	6	22	11	9	22	42	11	18	42
6	17	-	5	22	13.5	8	18	42	13.5	14	35
8	7	-	14	22	17	6	15	42	17	12	28
8	9	-	11	24	7	16	38	42	21	9	22
8	11	-	9	24	9	12	30	42	26	8	18
8	13.5	-	8	24	11	10	24	42	32.5	6	15
8	17	-	6	24	13.5	8	20	48	11	20	48
10	7	-	17	24	17	7	16	48	13.5	16	40
10	9	-	14	26	9	13	32	48	17	13	32
10	11	-	11	26	11	11	26	48	21	11	26
10	13.5	-	9	26	13.5	9	22	48	26	9	21
10	17	-	7	26	17	7	17	48	32.5	7	17
12	7	-	21	26	21	6	14	48	13.5	16	40
12	9	-	16	28	9	14	35	54	13.5	18	44
12	11	-	13	28	11	12	28	54	17	15	35
12	13.5	-	11	28	13.5	10	23	54	21	12	29
12	17	-	9	28	17	8	19	54	26	10	23
14	7	9	22	28	21	6	15	54	32.5	8	19
14	9	7	18	30	9	15	37	63	13.5	21	52
14	11	6	14	30	11	13	30	63	17	17	41
14	13.5		12	30	13.5	10	25	63	21	14	33
14	17	4	10	30	17	8	20	63	26	11	27
16	7	11	26	30	21	7	16	63	32.5	9	22
16	9	8	20	32	9	16	40	65	13.5	22	53
16	11	7	16	32	11	14	32	65	17	18	43
16	13.5	6	14	32	13.5	11	27	65	21	14	35
16	17	5	11	32	17	9	21	65	26	12	28
				32	21	7	17	65	32.5	9	22

Opening Movable Jaws

Step One

After the joint has cooled for the recommended time, shift the carriage control valve to the neutral position.

Step Two

Loosen all clamp knobs, and move carriage to the right far enough to open the jaw nearest the facer. Open the movable jaws.



Opening Fixed Jaws

Open the fixed jaws.

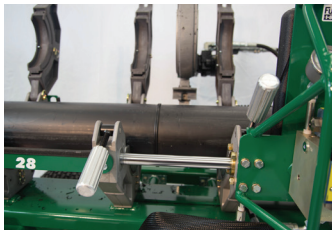

Raise Pipe

Step One

Raise the joined pipe using the pipe lift(s).

Step Two

Pull pipe through machine, and prepare for making next fusion. Inspect joint (page 53) and if it is unacceptable, use Troubleshooting Guide (page 54) to determine problem and make adjustments before next fusion.



The Inspection of the Fusion Joint

GOLDEN RULE

If in doubt, cut it out and start over.

The double bead should be rolled over onto the adjacent surfaces, and be uniformly rounded and consistent in size all around the joint. As illustrated in the Figure below, all beads will not necessarily have equal size. The cleavage between the beads must not be lower than the wall of the pipe as shown in the lower right illustration.

When butt fusing pipe to molded fittings, the fitting side bead may have an irregular appearance. This is acceptable provided the pipe side bead is correct.

It is not necessary for the internal bead to roll over to the inside surface of the pipe.

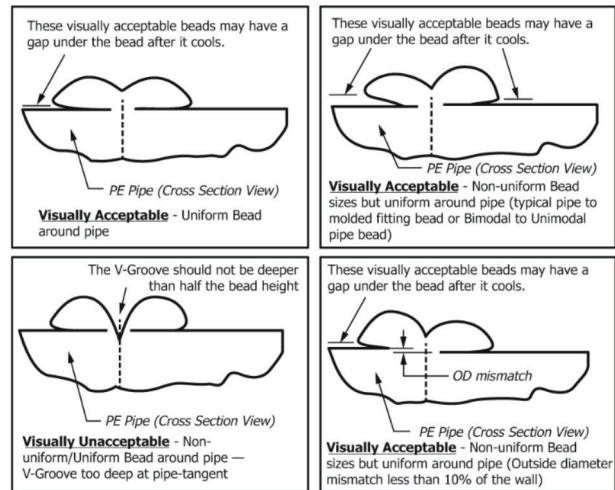

FIG. 5 Outside Diameter Butt Fusion Bead Guideline

Courtesy of ASTM F2620-20ae2

ASTM F2620-20ae2 also has the following notes for review of butt fusions:

NOTE 11: When butt fusing to molded fittings, the fitting-side bead may display shape irregularities such as minor indentations, deflections, ripples, non-uniform bead rollover from molded part cooling and knit lines, and other surface effects. In such cases, visual evaluation is based mainly on the size and shape of the pipe-side bead.

Continued on next page

(IMPORTANT Continued)

NOTE 12: For butt fusions between compatible polyethylene materials having different polymer characteristics (that is, unimodal to bimodal, high density to medium density, pipe to fitting, etc.) the fusion bead may be visually different on either side of the joint. These differences do not affect the integrity of the fused joint.

NOTE 13: ASTM F2620 Appendix X2 provides examples of unacceptable fusion joint appearances.

Butt Fusion Joint Troubleshooting Guide

Observed Condition	Potential Factors
Squarish outer bead edge	Pressure during heating
Flat top on bead	Excessive joining force, overheating
Beads too small	Insufficient heating; Insufficient joining force
Rough, sandpaper-like, bubbly, or pockmarked melt bead surface	Hydrocarbon contamination
Double v-groove too deep	Excessive joining force, insufficient heating, pressure during heating
A third bead	Excessive joining force



Cross section view of butt fusion melt pattern with bead

Position Pipe for Next Joint

Move the fusion machine to the end of pipe, or pull the pipe through the jaws until the end of the pipe is protruding more than 1" (This distance changes with fusion machine type.) past the jaw face of the fixed jaw.



Install Next Piece of Pipe

Insert a new piece of pipe in the movable jaws and repeat all previous procedures.

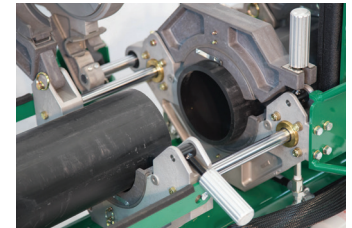

McELROY



■ SADDLE FUSION MACHINE PROCEDURE

Saddle Fusion Machine Procedure

The theory of heat fusion is to heat two surfaces to a designated temperature, creating a melt zone, and then fuse them together by application of force. This pressure enables flow of the melted materials, resulting in mixing and entanglement of long-chain molecules, and thus fusion. When the polyethylene material is heated, the molecular structure is transformed from a crystalline state into an amorphous condition. When fusion pressure is applied, the molecules from each polyethylene part mix. As the joint cools, the molecules return to their crystalline form, the original interfaces are gone, and the two pipes become one homogeneous unit. A strong, fully leak-tight connection is the result.

The principle operations include:

- Clamping:** The pipe and fitting must be held firmly to allow all subsequent operations to take place.
- Cleaning:** The area of pipe that the fitting will come in contact with must be cleaned and roughed up, as well as the base of the fitting.
- Alignment:** The fitting must be properly seated on the pipe and then clamped in the machine for proper alignment.
- Heating:** A melt pattern must be formed that penetrates into the pipe and into the fitting.
- Joining:** The melt patterns must be joined with a specified force. The force must be constant around the interface area.
- Holding:** The molten joint must be held immobile with a specified force until adequately cooled.

Definitions

Initial Heat (Bead-up): The heating step used to develop an initial melt bead on the main pipe.

Initial Heat Force (Bead-up force): The force (pounds) applied to establish an initial melt pattern on the main pipe. The Initial Heat Force is determined by multiplying the fitting base (in.²) area by the initial heat interfacial pressure 60 (lb./in.²). This force is twice the fusion force.

Definitions

Heat Soak Force: The force (pounds) applied after an initial melt pattern is established on the main pipe. The Heat Soak Force is the minimum force (essentially zero pounds) that ensures that the fitting, heater, and main stay in contact with each other.

Fusion Force: The force (pounds) applied to establish the fusion bond between the fitting base and the pipe. The Fusion Force is determined by multiplying the fitting base area (in.²) by the fusion interfacial pressure 30 (lb./in.²).

Fusion Interfacial Pressure: The amount of pressure determined by ASTM F2620 & PPI TR 41 as the optimum for interaction between HDPE pipe and saddle base, 30 (lb./in.²).

Total Heat Time: A time that starts when the heater is placed on the main pipe and initial heat force is applied and ends when the heater is removed.

Cool Time: The time required to cool the joint to approximately 120° F (49° C). The fusion force must be maintained for five minutes on 1-1/4" IPS or ten minutes for all other main sizes, after which the saddle fusion equipment can be removed. The joint must be allowed to cool undisturbed for an additional 30 minutes before tapping the main or joining to the branch outlet.

Interfacial Area for Rectangular Base Fittings: The major width times the major length of the saddle base, without taking into account the curvature of the base or sides, minus the area of the hole in the center of the base.

Interfacial Area for Round Base Fittings: The radius of the saddle base squared times π (3.1416), without taking into account the curvature of the base or sides, minus the area of the hole in the center of the base.

Fitting Label: The Initial Heat Force, Heat Soak Force, and the Fusion Force may be listed in the lower right corner of the fitting label for all saddle fusion fittings. This will eliminate the need to calculate the fusion forces in the field (example 80/0/40). Some manufacturers have this information on fitting labels but not all (see photo on page 60).

How to Calculate Fusion Pressures

Round Base

$$\frac{(\text{O.D. of Base} - \text{Wall Thickness}) \times \text{Wall Thickness} \times 3.14 \times \text{IFP}^*}{\text{TEPA}^{**}} + \text{Drag}$$

Tip: Work top line of formula left to right, then divide total number by TEPA

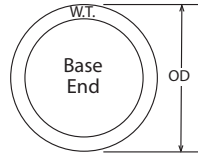

Rectangular Base

$$\frac{L \times W - (d \times d \times .7854) \times \text{IFP}^*}{\text{TEPA}^{**}} + \text{Drag}$$

Tip: Work top line of formula left to right, then divide total number by TEPA

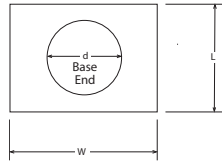

Notes:

* IFP = Interfacial Fusion Pressure is typically 30 psi for Saddle Fusion

**TEPA = Total Effective Piston Area

Fusion Machine Model	High Force (Green Cylinders)	Medium Force (Orange Cylinders)	Manual
Sidewinder	N/A	N/A	1 in ²
28 CU	4.71 in ²	N/A	N/A
412 CU	11.78 in ²	6.01 in ²	N/A
618 CU	11.78 in ²	6.01 in ²	N/A

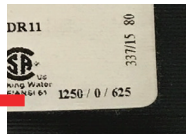

Tip: These three numbers left to right represent the Initial Heat Force (Bead-up Force), Heat Soak Force, and Fusion Force. These numbers should be divided by the TEPA and drag then added, if using a hydraulic fusion machine.

Prepare Fusion Machine

Step One

This procedure requires the use of a Saddle Fusion Tool like the example shown on the cover page of this procedure. This tool must be capable of holding and supporting the main, rounding the main for good alignment between the pipe and fitting, holding the fitting, applying and indicating the proper force during the fusion process.

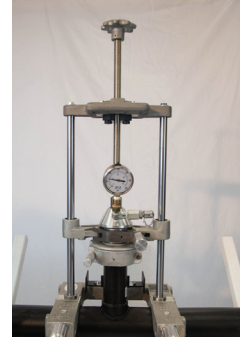

Step Two

Clean fitting and pipe. Install the Saddle Fusion Tool on the main according to the manufacturer's instructions. The tool should be centered over a clean, dry location where the fitting will be fused. Secure the tool to the main. A main bolster or support is recommended under the pipe on 6" IPS and smaller main pipe sizes.



Step Three

Abrade the fusion surface of the fitting with 50 to 60 grit utility cloth; to remove oxidation layer and contaminants. After abrading, brush residue away with a clean, dry, lint-free, non-synthetic cloth, such as cotton.



Step Four

Insert the fitting in the Saddle Fusion Tool loosely.

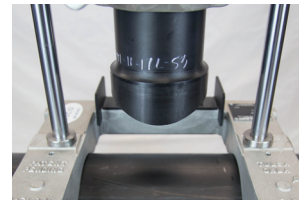

Continued on next page

Prepare Fusion Machine

Prepare Fusion Machine Continued

Step Five

Abrade the fusion surface of the main with a 50-60 grit utility cloth to remove oxidation layer and contaminates. The abraded area must be larger than the area covered by the fitting base. After abrading, brush residue away with a clean, dry, lint-free, non-synthetic cloth, such as cotton.

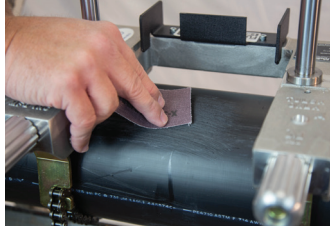

Step Six

Using the Saddle Fusion Tool, move the fitting base onto the main and apply about 100 pounds force to seat the fitting. Secure the fitting in the Saddle Fusion Tool.

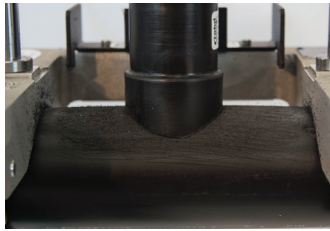

Heating



DANGER

Danger! Heater is Not Explosion Proof. If working in a hazardous environment review pages **6, 11-13** in the Safety Section.



CAUTION

Incorrect heating temperature can result in questionable fusion joints. Check heater plates periodically in multiple locations with a pyrometer and make necessary adjustments.

The heater must be fitted with the correct heater adapters. Serrated heater adapters are recommended to allow for maximum heat penetration.

The non-stick coating on the heater adapters should be in good condition. The temperature of the heater adapter fusion surfaces must be 490-510° F, with **500°F being Optimum**.

IMPORTANT

The dial thermometer on the heater indicates internal temperature. Due to the thickness of convex and concave heater plates, the temperature of the dial thermometer will not likely be the same as the surface temperature. The dial thermometer can be used as reference once the surface temperature has been verified.

Installing Fusion Heater Adapters

The heater body of this assembly is not coated. Coated heater adapters are available for all fusion applications. Heater adapters are installed with Stainless Steel Cap Screws. Care should be taken to assure that the heater adapters are seated on the heater body, and that there is no foreign matter trapped between these surfaces.

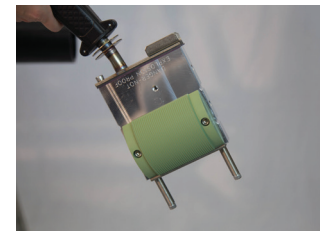

IMPORTANT

Do not overtighten the bolts, to allow for heater body expansion during heat up. The surface of the heater adapters is coated with an anti-stick coating.

Heating Procedure For Small Fittings (< 2in. IPS)

Step One

Place the heating tool on the main centered beneath the fitting base. Immediately move the fitting against the heater faces, apply the Initial Heat Force, (see fitting label or use twice the calculated fusion pressure, see **page 60**), and start the heat time.



Step Two

During Heating, hold the heating tool in position by lightly supporting the heating tool handle. If not supported, the heating tool can slip out of position or displace the main or fitting melt and result in a poor joint.

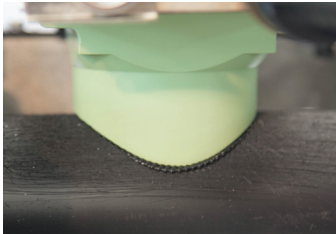

Step Three

Apply the Initial Heat Force until melt is first observed on the crown of the pipe main, (Initial Heat is the term used to describe the initial heating (bead-up) step to develop a melt bead on the main pipe and usually is 3-5 seconds) and then reduce the force to the Heat Soak Bead-up Force (see fitting label or use "0" psi). At the end of the Total Heat Time (See Maximum Heating Time and Minimum Cooling Time Table, **page 66**), remove the fitting from the heater and the heater from the main with a quick snapping action. Quickly check the melt pattern on the main pipe and fitting base for even melt patterns (no unheated areas).

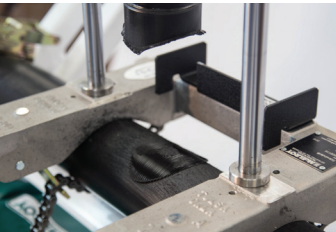

Heating Procedure For Large Fittings (> 3in. IPS/DIPS) and Large Mains (> 6in. IPS/DIPS)

Step One

Place the heating tool on the main centered beneath the fitting base while supporting the heating tool handle, and then place the Flexible Heat Shield between the heating tool and the fitting base. (This step could require an assistant to handle the Flexible Heat Shield).

Step Two

Move the fitting against the Flexible Heat Shield, apply Initial Heat Force, and observe melt bead formation on the main all around the heating tool faces.

Step Three

When a melt is first visible on the main all around the heating tool faces, in a quick continuous motion, release the Initial Heat Force, raise the fitting slightly, remove the Flexible Heat Shield, move the fitting against the heating tool face, apply Initial Heat Force and start the heat time.

Step Four

When a melt bead is first visible all around the fitting base (usually about 3 to 5 seconds) immediately reduce applied force to the Heat Soak Force (usually zero). Maintain the Heat Soak Force until the Total Heat Time ends (See Maximum Heating Time and Minimum Cooling Time Table, **page 66**). At the end of the Total Heat Time, remove the fitting from the heater and the heater from the main with a quick snapping action. Quickly check the melt pattern on the main pipe and fitting base for even melt patterns (no unheated areas).



Maximum Heating Time And Minimum Cooling Time Plus Rough Handling Time

Main OD	Wall Thickness	Pressure in Main Pipe	Max Heating Time	Min Cooling Time (with Fusion Pressure & Rough Handling Time)
1-1/4" IPS	(All)	Pressurized	Stop heating when about 1/16" bead is visible around the entire fitting base. DO NOT exceed 15 sec. when hot tapping (blow out may occur if main line is pressurized.)	5 min. + 30 min.
2" IPS	(All)	Pressurized	Stop heating when about 1/16" bead is visible around the entire fitting base. DO NOT exceed 25 to 35 sec. when hot tapping (blowout may occur if main line is pressurized.)	10 min. + 30 min.
≥1-1/4" IPS	(All)	Not Pressurized	Stop heating when about 1/16" bead is visible around the entire fitting base.	10 min. + 30 min.

Fusion and Cooling

Whether or not the melt patterns are satisfactory, press the fitting onto the main pipe very quickly (within 3 seconds) after removing the heater and apply the Fusion Force (See the fitting label or use the formula on **page 60** to calculate). Maintain the Fusion Force on the assembly for 5 minutes on 1-1/4" IPS mains and for 10 minutes on all larger sizes, after which the saddle fusion equipment may be removed.

(Fusion Force adjustment may be required during Cooling Time, but never reduce the Fusion Force during the cooling).

IMPORTANT

Visually check the fusion bead around the entire fitting base at the main pipe. The fusion bead should be uniformly sized all around the fitting base, and should have a characteristic "three-bead" shape. The first bead is the fitting base melt bead. The second or outermost bead is produced by the edge of the heating tool face on the main. The third or center bead is the main pipe melt bead. The first and third beads should be rounded and approximately 1/8" wide all around the fitting base. The second bead is usually smaller, but should also be uniformly sized around the fitting base. It is acceptable for this second melt bead to separate from the main pipe melt bead.

The assembly should cool for an additional 30 minutes before rough handling, branch joining, or tapping the main. Inspect fusion using the troubleshooting guide on **page 67** for proper melt patterns. If melt patterns are not satisfactory or if the fusion bead is unacceptable, cut off the saddle fitting above the base to prevent use and relocate to a new section of main. Then make a new saddle fusion using a new fitting.

These procedures are based on tests conducted under controlled ambient temperature conditions. Environmental conditions on a job site could affect heating and cooling times. Regardless of job site conditions or ambient temperature, the prescribed heating tool temperature is required. Do not increase or decrease the heating tool temperature.



Troubleshooting Guide

Observed Condition	Possible Cause
Beads too small	Insufficient heating; Insufficient joining force
No third bead, or third bead widely separated from center bead	Incorrect pipe main heating tool face or insufficient joining force
Serrated bead appearance	Normal for serrated heating tool faces
Smooth bead appearance	Normal for smooth heating tool faces
Pressurized main pipe blowout (beside base or through fitting center)	Overheating; Incorrect heating tool faces; Heating tool faces not within specified temperature; Taking too much time to start heating or to remove the heating tool and join the fitting to the main pipe
Rough, sandpaper-like, bubbly, or pockmarked Melt bead surface	Hydrocarbon contamination



■ SOCKET TOOLING & FUSION PROCEDURE

Socket Tooling and Fusion Procedure



Nomenclature

- | | |
|-----------------------------|---------------------|
| 1. Heater Sling | 5. Pipe Cutter |
| 2. Heater | 6. Fitting Holder |
| 3. Chamfer Tool/Depth Gauge | 7. Cold Ring Clamps |
| 4. Heater Adapters | |

Socket Tooling and Fusion Procedure

The theory of heat fusion is to heat two surfaces to a designated temperature, creating a melt zone, and then fuse them together by application of force. This pressure enables flow of the melted materials, resulting in mixing and entanglement of long-chain molecules, and thus fusion. When the polyethylene material is heated, the molecular structure is transformed from a crystalline state into an amorphous condition. When fusion pressure is applied, the molecules from each polyethylene part mix. As the joint cools, the molecules return to their crystalline form, the original interfaces are gone, and the two pipes become one homogeneous unit. A strong, fully leak-tight connection is the result.



The principle operations include:

- Clamping:** The pipe and fitting must be held firmly to allow all subsequent operations to take place.
- Cleaning:** The area of pipe that the fitting will come in contact with must be cleaned, as well as the base of the fitting.
- Alignment:** The fitting must be properly seated on the pipe for proper alignment.
- Heating:** A melt pattern must be formed that penetrates into the pipe and into the fitting.
- Joining:** The melt patterns must be joined with pressure. The pressure must be constant around the interface area.
- Holding:** The molten joint must be held immobile until adequately cooled.

Prepare Pipe End

Step One

Cut off damaged or oval ends of pipe squarely with a pipe cutter.



Step Two

Clean the pipe end and fitting, both inside and outside, by wiping with a clean, non-synthetic, dry, oil-free, lint-free cloth, such as cotton. Place the chamfering tool on end of pipe and turn clockwise to cut off sharp edge on top end of pipe. Remove shavings and burrs inside pipe end.

Depth Gauge and Cold Ring Clamp

The chamfering tool is also a depth gauge for measuring the length of pipe that will go into the fitting.

Place chamfering tool on end of pipe.

Place cold ring clamp on pipe at the bottom of the chamfering tool.

Remove chamfering tool.



Secure 2" And Larger Fittings

Place fitting in socket fitting holder.

Tighten socket fitting holder around coupling/fitting.



Clean Fitting And Pipe

Fitting and pipe must be clean and dry. Use a clean, dry, lint-free, non-synthetic cloth such as cotton to wipe the mating surfaces.

NOTICE
DO NOT touch with hands.



Heater Is Not Explosive Proof



DANGER

This heater is not explosion proof. Operation of heater in a hazardous

environment without necessary safety precautions can result in explosion and possible death. If operating in a hazardous environment the heater should be brought up to maximum recommended temperature in a safe environment, then unplugged before entering the hazardous atmosphere for fusion. Use a clean dry, lint-free, non-synthetic cloth to clean the heater adapter surfaces.



Heater Temperature



CAUTION

Incorrect heating temperature can result in questionable fusion joints. Check socket faces periodically in multiple locations with a pyrometer and make necessary adjustments.

The non-stick coating on the heater adapters should be in good condition. The socket faces of the heater must be at the correct temperature. Minimum 490° F, **Optimum 500°F**, Maximum 510° F.

IMPORTANT

The dial thermometer on the heater indicates internal temperature. The dial thermometer can be used as reference once the surface temperature has been verified.

Heating the Pipe and Fittings

Firmly seat the socket fitting on the male adapter on the heater. Place the female adapter of the heater over the end of the pipe, firmly against the cold ring clamp. Heat the pipe end and the fitting socket for the time required. See chart on **page 79** for proper heating time.

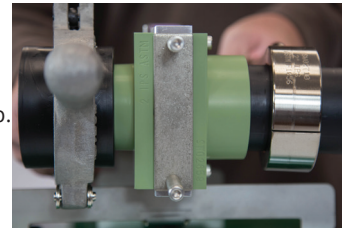

NOTICE

DO NOT twist fitting, pipe, or heater.

Remove Heater

At the end of the heating time, simultaneously remove the pipe and fitting straight out from the tool, using a snap action.

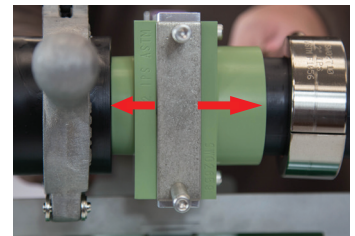

Inspect Melt

Quickly inspect the heated parts to make sure all surfaces have been melted properly.

If melt is not complete, cut off melted pipe end. Use a new fitting and repeat preparation and heating process over again.

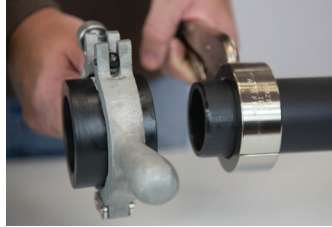

Fusion and Cooling

Step One

Immediately after the heater has been removed, firmly push the melted fitting squarely onto the pipe until it makes firm contact with the cold ring clamp.

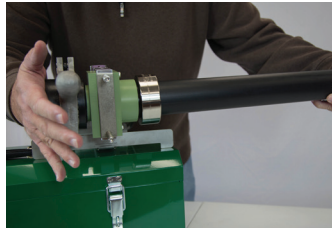

IMPORTANT

DO NOT twist or rotate the fitting.

Step Two

Hold the fitting firmly in place for the total cooling time. See chart on **page 79** for proper cooling time. Pipe and fitting **should be aligned straight with each other**.

Inspecting Fusion Joint

Step One

After completing the specified cooling and waiting time, remove the cold ring clamp and the socket fitting holder.

Step Two

Inspect the joint. A good joint will have a uniform melt ring that is flat against the socket fitting and perpendicular to the pipe.

Step Three

There should be no gaps, voids or unbonded areas between the fitting and the pipe. If the joint is questionable refer to the Troubleshooting Guide (**page 78**) for possible cause and adjustments that can be done before next fusion.

Step Four

Holding force may be relaxed when the cooling time ends. After an additional 3 minutes undisturbed cooling time, the Cold Ring Clamp can be removed. Allow an additional 10 minutes undisturbed cooling time before testing, backfilling, or stressing the joint.

Total Cooling Time equals time shown on chart (**page 79**) plus an additional 5 minutes.



Outside cross section of socket fusion.



Inside cross section of socket fusion.

Troubleshooting Guide

Observed Condition	Possible Cause
No cold-ring impression in socket fitting melt bead	Depth gauge not used; Cold ring clamp not used, or set at incorrect depth; Insufficient heat time
Gaps or voids around the pipe at socket fitting edge	Pipe or fitting removed straight from heater face (twisting or removing from heater face at an angle); Pipe or fitting not inserted straight into each other when fusing; joining together at an angle; Twisting while joining pipe and fitting together; Cold ring not used or set too deep
Wrinkled or collapsed pipe or tubing end (when viewed from inside, or when qualifying lengthwise cut joint)	Incorrect heating sequence always push the pipe or tubing into the heater after the fitting has been pushed on the heater (inserting the tubing first heats the tubing too long); Cold ring not used or set too deep
Voids in fusion bond area (when qualifying lengthwise cut joint)	Pipe or fitting not removed straight from heater face (twisting or removing from heater face at an angle); Pipe or fitting not inserted straight into each other when fusing; joining together at an angle; Twisting while joining pipe and fitting together; Cold ring not used or set too deep
Unbonded area on pipe or tubing at end of pipe or tubing (when qualifying lengthwise cut joint)	Cold ring not used or set too deep
Socket melt extends past end of pipe or tubing (when qualifying lengthwise cut joint)	Cold ring set too shallow
Rough, sandpaper-like, bubbly, or pockmarked melt bead surface	Hydrocarbon contamination

Heating and Cooling Times

Pipe Size	PE 2406/2708 (Yellow Pipe)		PE3408/3608/4710 (Black Pipe)	
	Heating Time (Sec.)	Cooling Times (Sec.)*	Heating Time (Sec.)	Cooling Times (Sec.)*
1/2" CTS	6-7	30	6-10	30
3/4" CTS	6-7	30	6-10	30
1" CTS	9-10	30	9-16	30
1-1/4" CTS	10-12	30	10-16	30
1/2" IPS	6-7	30	6-10	30
3/4" IPS	8-10	30	8-14	30
1" IPS	10-12	30	15-17	30
1-1/4" IPS	12-14	45	18-21	60
1-1/2" IPS	14-17	45	20-23	60
2" IPS	16-19	45	24-28	60
3" IPS	20-24	60	28-32	75
4" IPS	24-29	60	32-37	75

* Allow the joint to cool an additional five (5) minutes before exposing the joint to any type of stresses (that is, burial, testing or fusing the other end of the fitting.)

Installing Socket Fusion Heater Adapters

The heater body of this assembly is not coated. Coated heater adapters are available for all fusion applications. Heater adapters are installed with Stainless Steel Cap Screws. Care should be taken to assure that the heater adapters are seated on the heater body, and that there is no foreign matter trapped between these surfaces.



IMPORTANT

Do not overtighten the bolts, to allow for heater body expansion during heat up. The surface of the heater adapters is coated with an anti-stick coating.

Clean Heater Surfaces

The heater adapters must be kept clean and free of any plastic buildup or contamination.



CAUTION

Before and after each fusion is made, the surface of the heater adapters must be wiped with a clean, dry, lint-free, non-synthetic cloth such as cotton.



Adjusting Heater Temperature



CAUTION

Incorrect adjustment can result in injuries as well as machine damage. Follow these instructions carefully.

The heater thermoswitch adjustment shaft protrudes through the heater handle base. Turn the adjustment shaft clockwise to lower temperature, counter clockwise to raise temperature.

Allow sufficient amount of time for unit to stabilize at the new temperature (5 to 10 minutes) after each adjustment. One full turn equals approximately 100° F. (Old Style Heater)

REFERENCE INFORMATION



Power Requirements

Machine	Heater Power	Facer Power	Hydraulic	Min. Req.at sea level
MiniMc	300 Watt @ 120 VAC, 1Ph	Hand Operated	None	0.3 KW @ 120 VAC
No. 2LC/2CU	800 Watt @ 120 VAC, 1Ph	Hand Operated	None	0.8 KW @ 120 VAC
Socket Fusion	2" - 800 Watt @ 120 VAC, 1Ph 4" - 1,200 Watt @ 120 VAC, 1Ph	Not Applicable	None	2" - Heater - 0.8 KW @120 VAC 4" - Heater - 2.5 KW @120 VAC
No. 14/ No.26	1,200 Watt @ 120 VAC, 1Ph	7 Amps @ 120 VAC (Running) 22 Amps @ 120 VAC (Stall)	None	2.5 KW @120 VAC
Sidewinder	2" - 800 Watt @ 120 VAC, 1Ph 4" - 1,200 Watt @ 120 VAC, 1Ph	Not Applicable	None	2" - Heater - 0.8 KW @120 VAC 4" - Heater - 2.5 KW @120 VAC
No. 28	1,750 Watt @ 120 VAC, 1Ph	Hydraulic	1 1/2HP, 1Ph @ 120 VAC	3.5 KW @120 VAC
No. 28CU	1,750 Watt @ 120 VAC, 1Ph Saddle - 2,270 Watt @ 240 VAC	Hydraulic	1 1/2HP, 1Ph @ 120 VAC	4 KW @120 VAC
TracStar 28	1,750 Watt @ 120 VAC, 1Ph Saddle - 2,270 Watt @ 240 VAC	Hydraulic	Self-Contained	Self-Contained Gasoline
TracStar 28 Series II	1,750 Watt @ 120 VAC, 1Ph Saddle - 2,270 Watt @ 240 VAC	Hydraulic	Self-Contained	Self-Contained Diesel
No. 412E	3,000 Watt @ 240 VAC, 1Ph	Hydraulic	3 HP, 3Ph @ 240 VAC	5.5 KW / 6.5 KVA @ 240 VAC 60Hz
No. 618E	3,000 Watt @ 240 VAC, 1Ph	Hydraulic	5 HP, 3Ph @ 240 VAC	6.5 KW / 7.5 KVA @ 240 VAC 60Hz
No. 412/ No. 618	3,000 Watt @ 240 VAC, 1Ph	Hydraulic	Self-Contained	Self-Contained Gasoline

Power Requirements

Machine	Heater Power	Facer Power	Hydraulic	Min. Req. at sea level
TracStar 412 Series II / TracStar 618 Series II	3,000 Watt @ 240 VAC, 1Ph	Hydraulic	Self-Contained	Self-Contained Diesel
TracStar 500	4,000 Watt @ 240 VAC, 1Ph	Hydraulic	Self-Contained	Self-Contained Diesel
No. 824	10,950 Watt @ 240 VAC, 3Ph	Hydraulic	20 HP, 3Ph @ 240 VAC	30 KW / 30 KVA @ 240 VAC 60Hz
TracStar 630 Series II	10,950 Watt @ 240 VAC 3Ph	Hydraulic	Self-Contained	Self-Contained Diesel
No. 1236	20,461 Watt @ 240 VAC, 3Ph	Hydraulic	20 HP, 3Ph @ 240 VAC	30 KW / 30 KVA @ 240 VAC 60Hz
TracStar 900 Series II	20,461 Watt @ 240 VAC, 3Ph	Hydraulic	Self-Contained	Self-Contained Diesel
No. 1648	35,000 Watt @ 240 VAC, 3Ph	Hydraulic	10 HP, 3Ph @ 240 VAC	50 KW / 50 KVA @ 240 VAC 60Hz
TracStar 1200	35,000 Watt @ 240 VAC, 3Ph	Hydraulic	Self-Contained	Self-Contained Diesel
No. 2065	65"- 38,437 Watt @ 240 VAC, 3Ph 48"- 35,000 Watt @ 240 VAC, 3Ph	Hydraulic	10 HP, 3Ph @ 240 VAC	50 KW / 50 KVA @ 240 VAC 60Hz
1600	65"- 38,437 Watt @ 240 VAC, 3Ph 48"- 35,000 Watt @ 240 VAC, 3Ph	Hydraulic	25 HP, 3Ph @ 240 VAC	65 KW / 65 KVA @ 240 VAC 60Hz

Pipe Size Reference Charts

IPS Pipe Sizes		
Pipe	OD	Circumference
1/2"	0.84"	2.64"
3/4"	1.05"	3.30"
1"	1.315"	4.13"
1 1/4"	1.66"	5.22"
1 1/2"	1.90"	5.97"
2"	2.375"	7.46"
2 1/2"	2.875"	9.03"
3"	3.50"	11.00"
4"	4.50"	14.14"
5"	5.56"	17.47"
6"	6.625"	20.81"
8"	8.625"	27.10"
10"	10.75"	33.77"
12"	12.75"	40.06"
14"	14.00"	43.98"
16"	16.00"	50.27"
18"	18.00"	56.55"
20"	20.00"	62.83"
22"	22.00"	69.12"
24"	24.00"	75.40"
26"	26.00"	81.68"
28"	28.00"	87.96"
30"	30.00"	94.25"
32"	32.00"	100.53"
34"	34.00"	106.81"
36"	36.00"	113.10"
42"	42.00"	131.95"
48"	48.00"	150.80"
52"	52.00"	163.36"
54"	54.00"	169.65"
63"	63.00"	197.92"

DIPS Pipe Sizes		
Pipe	OD	Circumference
4"	4.80"	15.08"
6"	6.90"	21.68"
8"	9.05"	28.43"
10"	11.10"	34.87"
12"	13.20"	41.47"
14"	15.30"	48.07"
16"	17.40"	54.66"
18"	19.50"	61.26"
20"	21.60"	67.86"
24"	25.80"	81.05"
30"	32.00"	100.53"
36"	38.30"	120.32"
42"	44.50"	139.80"
48"	50.80"	159.59"
54"	57.10"	179.38"
60"	61.61"	193.55"

CTS Pipe Sizes		
Pipe	OD	Circumference
1/2"	0.625"	1.98"
3/4"	0.875"	2.75"
1"	1.125"	3.53"
1 1/4"	1.375"	4.32"
1 1/2"	1.625"	5.11"
2"	2.125"	6.68"

Metric ISO Pipe Sizes		
Pipe	OD	Circumference
20 mm	0.79"	2.48"
25 mm	0.98"	3.09"
32 mm	1.26"	3.96"
50 mm	1.97"	6.18"
63 mm	2.48"	7.79"
75 mm	2.95"	9.28"
90 mm	3.54"	11.13"
100 mm	3.94"	12.37"
110 mm	4.33"	13.61"
125 mm	4.92"	15.46"
150 mm	5.91"	18.55"
160 mm	6.30"	19.79"
180 mm	7.09"	22.26"
200 mm	7.87"	24.74"
225 mm	8.86"	27.83"
250 mm	9.84"	30.92"
280 mm	11.02"	34.63"
315 mm	12.40"	38.96"
340 mm	13.39"	42.05"
355 mm	13.98"	43.91"
400 mm	15.75"	49.47"
450 mm	17.72"	55.66"
500 mm	19.69"	61.84"
560 mm	22.05"	69.26"
630 mm	24.80"	77.92"
710 mm	27.95"	87.82"
800 mm	31.50"	98.95"
900 mm	35.43"	111.32"
1000 mm	39.37"	123.68"
1200 mm	47.24"	148.42"
1400 mm	55.12"	173.16"
1600 mm	62.99"	197.90"
1800 mm	70.87"	222.63"
2000 mm	78.74"	247.37"
2250 mm	88.58"	278.29"
2500 mm	98.43"	309.21"

Metric JIS-1, 1U, 2, 3 Pipe Sizes		
Pipe	OD	Circumference
40 mm	1.89"	5.94"
50 mm	2.36"	7.41"
75 mm	3.50"	11.00"
100 mm	4.49"	14.10"
125 mm	5.51"	17.31"
150 mm	6.49"	20.39"
175 mm	7.48"	23.50"
200 mm	8.50"	26.70"
250 mm	10.51"	33.02"
300 mm	12.52"	39.33"
350 mm	14.57"	45.77"
400 mm	16.54"	51.96"

OD Pipe Sizes		
Pipe	OD	Circumference
2 5/8"	2.62"	8.25"
4 1/4"	4.25"	13.35"
6.27"	6.27"	19.70"
7 1/8"	7.12"	22.38"
21 1/2"	21.50"	67.54"

Cold and Inclement Weather Procedures

Wind and Precipitation: Heating tool shall be shielded in insulated container to prevent excessive heat loss. Shield the pipe fusion area and fusion tools from wind, snow, blowing dust and rain by using a canopy or similar device. Open pipe ends should be covered with plugs or covers to protect the heater from unacceptable temperature variations. Protective measures with auxiliary heating is recommended when temperatures are below -4°F (-20°C).

Pipe and Fitting Surface Preparation: The pipe and fitting surfaces to be "joined" or held in clamps shall be dry, clean and free of ice, frost, snow, dirt, and other contamination. After regular procedure for facing, the surface shall be protected from contamination until the fusion procedure including cooling time is complete.

Heating: Check the temperature of the heating tool regularly with a pyrometer or other surface temperature measuring device. Do not increase heating tool temperature above the maximum recommended temperature setting. Work quickly once pipe and fittings have been separated from the heating tool; so that melt heat loss is minimized, but still take time (no more than 3 seconds) to inspect both melt patterns. When the ambient temperature becomes colder, it will require a longer heating time to develop an indication of melt and the final bead size.

Pre-Heating: When the ambient temperature is below 3°F (-16°C), the pipe ends shall be pre-heated using a heating blanket or warm air device to elevate the pipe temperature to improve the heating starting condition. With pipe mounted in the fusion machine, an alternate method of pre-heating is to stop the pipe ends within .25-.50 inches (6.4-12.7mm) of the heater plate face to allow the pipe ends to warm for 30 seconds to 2 minutes, depending on the pipe size and wall.

Hydraulic Fluid Characteristics Chart

The use of proper hydraulic oil is mandatory to achieve maximum performance and machine life. Use a clean, high-quality, anti-wear hydraulic oil with a viscosity index (VI) of 135 minimum. It should have a maximum viscosity of 500 cSt (2000 SSU) at startup (ambient temperature) and a minimum viscosity of 13 cSt (65 SSU) at the maximum oil temperature (generally 80°F above ambient). Using hydraulic oils that do not meet these criteria may cause poor operation and/or damage to the hydraulic components. The table on the following pages specifies the oil temperature at various viscosities. Temperature rise of the hydraulic oil can vary from 30° F to about 80° F over the ambient temperature depending on the pressure setting, age of the pump, wind, etc. Mobil Univis N46 hydraulic oil is installed in new equipment. The advantage of this oil is a wider temperature range; however, this oil should not be used for continuous operation below 24° F. For use in extremely cold ambient temperatures, we suggest Mobil DTE 10 Excel 15, which can be used to -16° F. This oil should not be used for continuous operation above 113° F (oil temperature).

HYDRAULIC FLUID CHARACTERISTICS												
FLUID	cSt 100F	cSt 210F	Viscosity Index	-30°F -34°C	-15°F -26°C	0°F -18°C	15°F -9°C	30°F -1°C	45°F 7°C	60°F 15°C	75°F 24°C	
DTE 10 Excel 15	15.8	4.1	168									
DTE 10 Excel 32	32.7	6.6	164									
DTE 10 Excel 46	45.6	8.5	164									
DTE 10 Excel 68	68.4	11.2	156									
DTE 10 Excel 100	99.8	13	127									
Univis N32	34.9	6.9	164									
Univis N46	46	8.5	163									
Univis N68	73.8	12.1	160									
Synthetic SHC 525	46	8.5	154									

FLUID	90°F 32°C	105°F 40°C	120°F 49°C	135°F 57°C	150°F 65°C	165°F 74°C	180°F 82°C	195°F 90°C	RANGE
DTE 10 Excel 15									-16°F to 113°F -27°C to 45°C
DTE 10 Excel 32									-12°F to 154°F -11°C to 68°C
DTE 10 Excel 46									23°F to 173°F -5°C to 78°C
DTE 10 Excel 68									37°F to 196°F 3°C to 91°C
DTE 10 Excel 100									55°F to 214°F 13°C to 101°C
Univis N32									12°F to 150°F -11°C to 66°C
Univis N46									24°F to 166°F -4°C to 74°C
Univis N68									39°F to 193°F 4°C to 89°C
Synthetic SHC 525									19°F to 180°F -7°C to 82°C

Heater Adapter Code System

Heater Size (2" or 4") Pipe OD (i.e. 2.37")

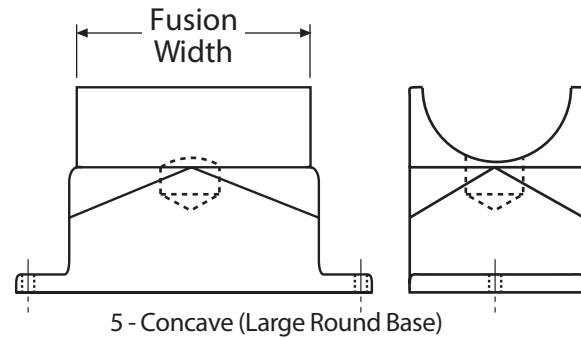
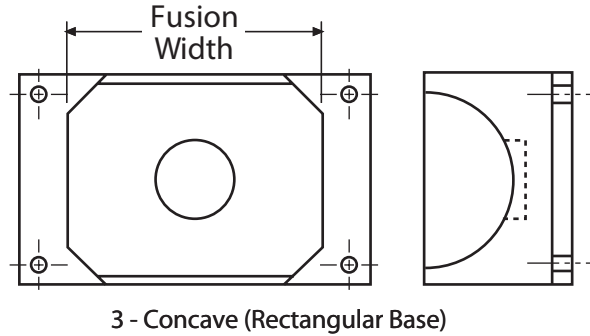
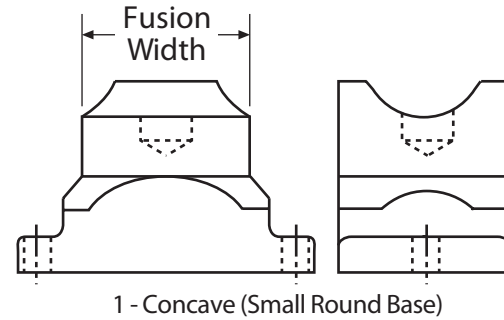
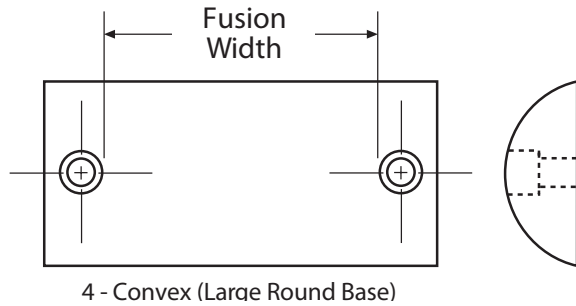
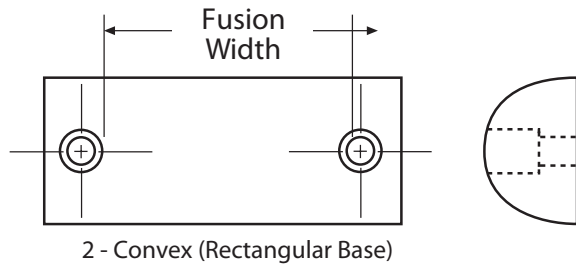
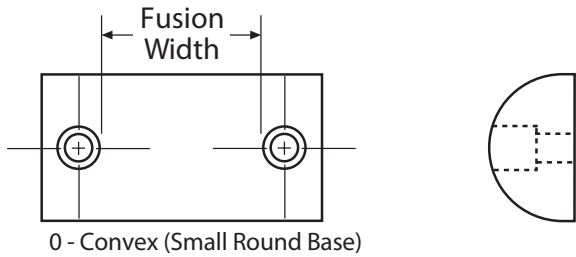
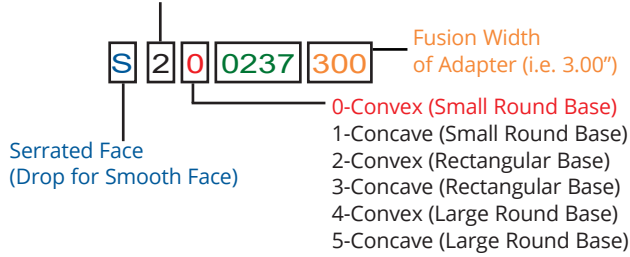

DataLogger® 6 Operation

DataLogger® 6 Hardware Components

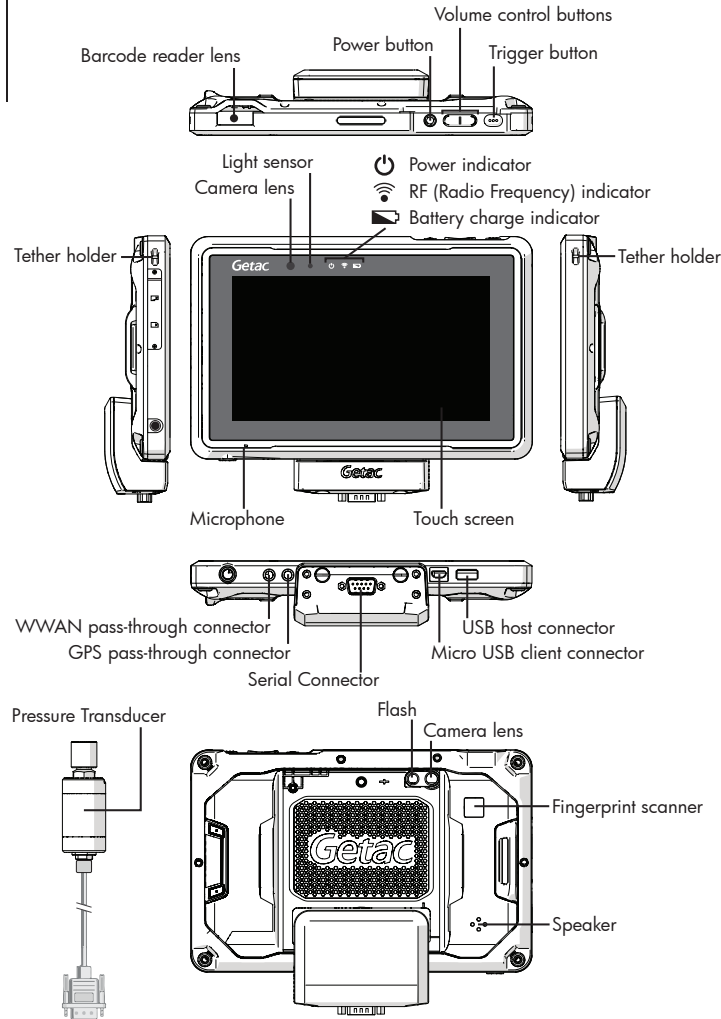

DataLogger® 6 Operation Continued

Getting Started

Installing the SIM Card (Optional)

1. Remove the screw from the SIM card cover and flip open the cover.
2. With the SIM card's chip side facing the back of the device and the beveled corner pointing to the slot, insert the card all the way into the slot.

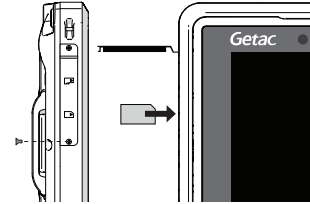

3. Close the cover and tighten the screw.

Charging the Battery

Connect the AC adapter to charge the battery.

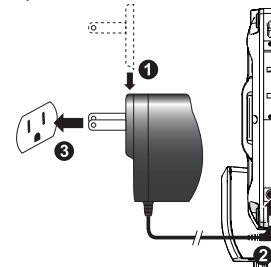

The battery charge indicator glows in amber when charging is in progress. When the battery is fully charged, the amber indicator turns to green.

Performing the Initial Startup

1. Press the power button to turn on your device.
2. Follow the on-screen instructions to complete the setup process. After the setup is completed, the Home screen appears. You can now use your device.

Operating Basics

Waking Up

Your device sleeps after a period of inactivity.

To wake up, press the power button and, at the lock screen, drag the lock icon to the other side of the screen.

Shutting Down

To shut down, press and hold the power button until a menu pops up. Touch Power off and then OK.

Home Screen

The Home screen is your starting point to access all the features on your device.



Navigation bar:

- goes back to the previous screen.
- opens the Home screen.
- opens a screen containing thumbnails of application you've used recently.

General Safety

⚠ DANGER DataLogger® equipment is not explosion proof.

Operation of equipment in an explosive atmosphere may result in serious injury or death.

Do not operate this equipment in an explosive atmosphere.

⚠ CAUTION Do not stare into beam of the laser. Damage to eyes could occur. Point the laser only at the object you are scanning.

DataLogger® App

Connect Pressure Transducer to Fusion Machine

1. Connect the pressure transducer end of the cable to the DataLogger port of fusion machine. Refer to the operator's manual of the fusion machine for the port location.
2. Connect the serial connector end of the cable to the serial port of the tablet.



Starting the DataLogger® 6 App

1. Open to the Home screen.
2. Tap the DataLogger® 6 App icon to open the application.

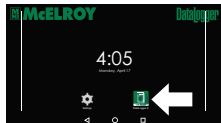

Select Software Language

1. Tap Settings on the Main Menu.



2. Tap Preferences on the Settings Menu.



3. Tap the Language button and set to the desired language.



Entering Vault Information

1. Tap the lock icon on the main screen to open the DataLogger® Vault™ log in screen.
2. Log into a DataLogger® Vault™ account using a username and password.

If you do not have a Vault account, open an internet browser on this tablet and go to vault.mcelroy.com. Create an account and return to the DataLogger 6 App and enter the username and password.

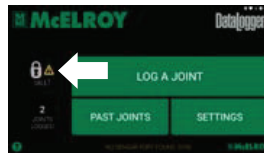

Log a Fusion Joint

1. Tap the Log a Joint button.
2. Follow the on-screen instructions to enter all the joint information and select the fusion parameters. After the setup is completed, logging of the fusion joint can begin.

Troubleshooting

Perform a Hard Reset

1. If the device freezes, a hard reset may fix the issue.

To perform a hard reset: Hold the Power button for 10-12 seconds until the device restarts.

DataLogger® 7 Operation

DataLogger® 7 Hardware Components

Front and Back Features

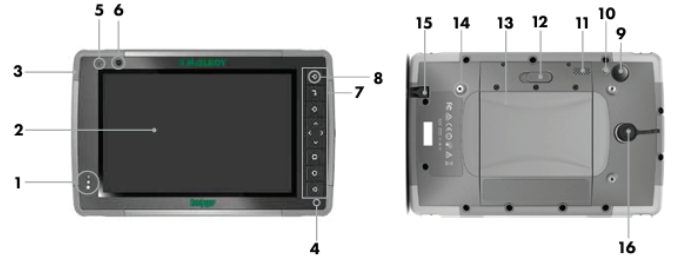

- | | |
|--|--|
| 1 Notification LEDs | 9 Rear Facing Camera Lens, 16 MP |
| 2 Touchscreen and Display | 10 Camera Flash |
| 3 Protective Over-molded Bumper (all four edges) | 11 Speaker |
| 4 Microphone (one on each side) | 12 Battery Door Lock |
| 5 Ambient Light Sensor | 13 Battery Compartment, SIM and SD Card Slots |
| 6 Front Facing Camera Lens, 2 MP | 14 External Device Attachment Point (1 of 3 on the back) |
| 7 Keypad | 15 Storage Slot for Fine Tip Stylus |
| 8 Power Key | 16 Switchcraft Connector Port |

Battery Compartment and Card Slots



- 1 Battery Pack, Removable
- 2 Battery Door
- 3 Micro SIM Card Slot and Micro SD/SDHC Card Slot (under card retainer)
- 4 Flexible Card Retainer
- 5 Battery Compartment
- 6 Docking Port Connections

Connector Ports

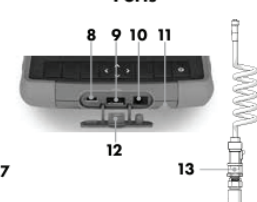

- 7 Hand Strap Attachment Point
- 8 USB-C, USB 3.1, 5V 1.5A Max Output
- 9 USB 2.0 Host, 5V 500mA Max Output
- 10 12 VDC Power Input Jack
- 11 Storage Slot for Fine Tip Stylus
- 12 Connector Port Protector
- 13 Transducer and Cable

Installing the SIM Card and SD Card (Optional)

1. Slide the battery compartment lock (A) to the unlocked position.

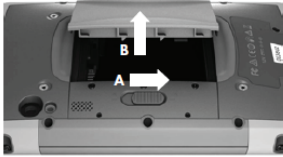

2. Remove the compartment door (B). Remove the battery. The Micro SIM and SD cards slots are under the battery. Pull flexible card holder out of the way.



3. Insert SIM card into the proper slot. Push flexible card holder back into place.
4. Replace the battery and reattach door and lock. Activate SIM card per carrier instructions.

Charging the Battery

Connect the AC adapter to charge the battery.



The LED battery charge indicator blinks red when the unit is plugged in and the battery is charging. The LED indicator will be solid red when the battery is charged (not charging).

TR05409-10-15-20

Performing the Initial Startup

1. Press the power button to turn on your device.
2. Follow the on-screen instructions to complete the setup process.
After the setup is completed, the Home screen appears. You can now use your device.
3. The tablet will include a formatted and installed SD card from McElroy. If a new SD card is installed, you will need to format the card to use with the device.

Waking Up

Your device sleeps after a period of inactivity.

To wake up, press the power button and, at the lock screen, drag the lock icon to the other side of the screen.

Shutting Down



To shut down, press and hold the power button until a menu pops up. Touch Power off and then OK.

Home Screen

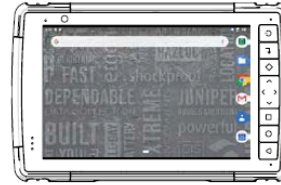
The Home screen is your starting point to access all the features on your device.



Navigation bar:

-  opens a screen containing thumbnails of application you've used recently.
-  opens the Home screen.
-  goes back to the previous screen.

DataLogger® App

Connect Pressure Transducer to Fusion Machine

1. Connect the pressure transducer end of the cable to the DataLogger part of fusion machine. Refer to the operator's manual of the fusion machine for the port location.
2. Connect the connector end of the cable to the connector port on the back of the tablet.

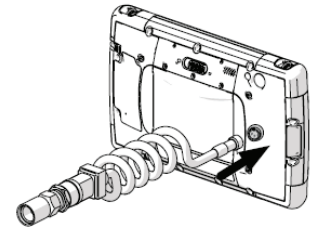

Starting the DataLogger® 7 App

1. Open to the Home screen.
2. Tap the DataLogger® 7 App icon to open the application.



Select Software Language

1. Tap Settings on the Main Menu.

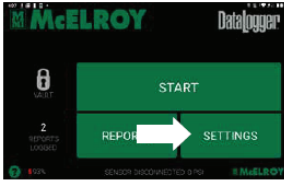

2. Tap Preferences on the Settings Menu.

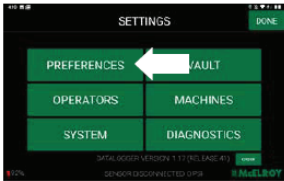

3. Tap the Language button and set to the desired language.

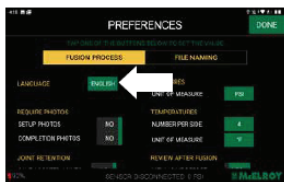

Entering Vault Information

1. Tap the lock icon on the main screen to open the DataLogger® Vault™ log in screen.
2. Log into a DataLogger® Vault™ account using a username and password.

If you do not have a Vault account, open an internet browser on this tablet and go to vault.mcelroy.com. Create an account and return to the DataLogger 7 App and enter the username and password.

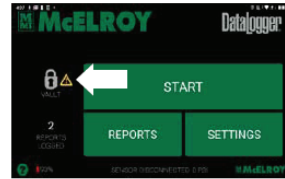

Log a Fusion Joint

1. Tap the START button.
2. Follow the on-screen instructions to enter all the joint information and select the fusion parameters.

After the setup is completed, logging of the fusion joint can begin.

TK05410-10-15-20

Perform a Hard Reset

1. If the tablet has froze and won't respond, hold the power key down for 2 to 3 seconds to see if the menu with the "Power off" option appears, then select that operation.

If the menu doesn't appear, hold the power key down for 10 seconds. This causes a hardware shut off. Press the power key again to power it on.

If hold the power key for 10 seconds doesn't shut off the device, hold the power button down for 20 seconds. Batteries are forced to electrically disconnect from the tablet, causing a complete shut down. The tablet cannot be powered on again until an external power supply is attached.

IMPORTANT: To be able to power the device on again, you will need to be able to use the external power supply. You will need to have access to a power source for the power supply.

NOTICE: Forcing a shut-down while the unit is running can cause damage to the device. NEVER force shut-down the tablet under normal operating conditions.

TK05411-10-15-20

Power Key



If Your Cylinders are Green

Machines: McElroy No. 28, McElroy TracStar 28,

Cylinders: Green (High Force) – 4.71 in² Piston Area

Heater Surface Temp: 425°F

Interfacial pressure: 75 psi

NOTE: Fusion pressure shown includes 30 psi for system drag.

IPS	Pipe Size	DR									
		7	9	11	13.5	15.5	17	19	21	26	32.5
	2"	65	58	53	49	47	46	-	-	-	-
	3"	105	91	81	72	67	64	61	58	53	-
	4"	154	130	114	99	91	86	81	76	67	60
	5"	220	183	158	136	123	116	107	100	87	76
	6"	299	247	211	181	163	152	139	130	111	95
	7"	341	281	240	204	183	171	157	145	124	106
	8"	486	398	338	285	255	236	216	199	168	141

DIPS	Pipe Size	DR						
		7	9	11	13.5	17	21	26
	4"	171	144	125	109	94	82	73
	6"	322	265	227	193	162	138	118
	8"	532	435	369	311	257	216	182



Remember!
You can always
download the
McCalc app from
the App Store.

If Your Cylinders are Yellow

Machines: McElroy No. 28, McElroy TracStar 28, DynaMc 28

Cylinders: Yellow (Low Force) – 1.66 in² Piston Area

Heater Surface Temp: 425°F

Interfacial pressure: 75 psi

NOTE: Fusion pressure shown includes 30 psi for system drag.

IPS	Pipe Size	DR									
		7	9	11	13.5	15.5	17	19	21	26	32.5
	2"	128	109	96	85	78	74	-	-	-	-
	3"	243	202	174	149	135	126	117	109	94	-
	4"	382	314	268	227	203	189	173	160	136	116
	5"	568	464	393	331	295	273	249	229	192	161
	6"	793	645	545	457	406	375	341	313	260	216
	7"	912	742	626	524	465	429	389	357	296	245
	8"	1,323	1,073	903	754	667	615	556	509	420	345

DIPS	Pipe Size	DR						
		7	9	11	13.5	17	21	26
	4"	430	353	300	254	211	178	151
	6"	857	697	588	493	404	336	280
	8"	1,453	1,178	991	827	674	557	460

If Your Cylinders are Green

Machines: McElroy No. 412, McElroy No. 618, McElroy TracStar 412, McElroy TracStar 618

Cylinders: Green (High Force) – 11. 78 in² Piston Area

Heater Surface Temp: 425°F

Interfacial pressure: 75 psi

NOTE: Fusion pressure shown includes 30 psi for system drag.

IPS	Pipe Size	DR									
		7	9	11	13.5	15.5	17	19	21	26	32.5
IPS	4"	80	70	63	58	54	52	50	48	45	42
	5"	106	91	81	72	67	64	61	58	53	48
	6"	137	117	103	90	83	79	74	70	62	56
	7"	154	130	114	100	91	86	81	76	68	60
	8"	212	177	153	132	120	112	104	97	85	74
	10"	313	258	221	189	170	158	145	135	115	99
	12"	428	351	299	253	226	210	192	177	150	127
	14"	510	417	354	299	267	247	225	208	175	147
	16"	657	536	453	381	339	313	285	262	219	183
	18"	824	670	566	474	421	389	353	324	270	223

DIPS	Pipe Size	DR						
		7	9	11	13.5	17	21	26
DIPS	4"	86	76	68	62	56	51	47
	6"	147	124	109	95	83	73	65
	8"	231	192	165	142	121	104	91
	10"	332	273	234	199	166	142	121
	12"	457	374	318	269	223	188	159
	14"	603	492	417	351	289	242	203
	16"	772	628	530	445	365	305	254



Remember!
You can always
download the
McCalc app from
the App Store.

If Your Cylinders are Orange

Machines: McElroy No. 412, McElroy No. 618, McElroy TracStar 412, McElroy TracStar 618, McElroy TracStar 500 Series II & Series 3 (Manifold Equipped)

Cylinders: Orange (Medium Force) - 6.01 in² Piston Area

Heater Surface Temp: 425°F

Interfacial pressure: 75 psi

NOTE: Fusion pressure shown includes 30 psi for system drag.

IPS	Pipe Size	DR									
		7	9	11	13.5	15.5	17	19	21	26	32.5
IPS	4"	127	108	96	84	78	74	70	66	59	54
	5"	179	150	130	113	103	97	90	85	75	66
	6"	241	200	172	148	134	125	116	108	94	81
	7"	274	227	194	167	150	140	129	120	104	89
	8"	387	318	271	230	206	191	175	162	138	117
	10"	585	477	404	341	303	281	256	235	198	165
	12"	810	659	557	467	415	383	348	319	266	220
	14"	971	789	665	557	494	455	413	378	314	259
	16"	1,259	1,021	859	718	636	586	530	485	401	329
	18"	1,585	1,285	1,080	901	797	733	663	606	500	409
T-500	20"	1,950*	1,579*	1,326	1,106	976	898	812	741	610	498

DIPS	Pipe Size	DR						
		7	9	11	13.5	17	21	26
DIPS	4"	141	119	105	92	80	71	63
	6"	259	214	184	158	133	115	99
	8"	423	347	295	250	208	176	149
	10"	621	507	429	361	297	249	209
	12"	866	705	595	499	408	340	283
	14"	1,154	936	788	659	538	446	369
	16"	1,483	1,202	1,011	844	687	568	469
T-500	18"	1,855*	1,502	1,262	1,052	855	706	581

* = Capable in T500 Series 3, not Series II

If Your Cylinders are Yellow

Machines: McElroy No. 412, McElroy No. 618, McElroy TracStar 412, McElroy TracStar 618, DynaMc 412

Cylinders: Yellow (Low Force) - 3.14 in² Piston Area

Heater Surface Temp: 425°F

Interfacial pressure: 75 psi

NOTE: Fusion pressure shown includes 30 psi for system drag.

Pipe Size	DR									
	7	9	11	13.5	15.5	17	19	21	26	32.5
4"	216	180	156	134	122	114	106	99	86	75
5"	314	259	222	189	170	159	146	135	116	99
6"	433	355	302	256	229	212	194	179	152	128
7"	496	406	345	291	260	241	220	203	171	144
8"	714	581	491	413	367	339	308	283	236	196
10"	1,092	886	747	625	553	510	462	423	351	289
12"	NC	1,235*	1,038	867	766	705	638	583	481	394
14"	NC	1,483*	1,245*	1,039	918	844	763	697	574	469
16"	NC	NC	NC	1,348*	1,189	1,094	988	901	740	603
18"	NC	NC	NC	NC	1,497*	1,376*	1,242*	1,133	929	755

Pipe Size	DR						
	7	9	11	13.5	17	21	26
4"	242	201	173	149	126	108	94
6"	467	383	325	275	228	192	162
8"	783	637	538	452	370	309	257
10"	1,162	943	794	664	542	449	372
12"	NC	1,321*	1,111	927	754	623	514
14"	NC	NC	1,482*	1,235*	1,002	827	680
16"	NC	NC	NC	NC	1,288*	1,060	870
18"	NC	NC	NC	NC	NC	1,324*	1,085

NC= Not Capable with Yellow Cylinder Machines

* = TracStar and DynaMc Units only, not possible for standard/rolling units



Remember!
You can always
download the
McCalc app from
the App Store.

If Your Cylinders are Green

Machines: McElroy No. 824, McElroy No. 1236, McElroy TracStar 630, McElroy TracStar 900 (Manifold Equipped)

Cylinders: Green (High Force) - 29.44 in² Piston Area

Heater Surface Temp: 425°F

Interfacial pressure: 75 psi

NOTE: Fusion pressure shown includes 30 psi for system drag.

Pipe Size	DR									
	7	9	11	13.5	15.5	17	19	21	26	32.5
8"	103	89	79	71	66	63	60	57	52	48
10"	143	121	106	93	86	81	76	72	64	58
12"	189	158	138	119	109	102	95	89	78	69
14"	222	185	160	138	125	117	108	101	88	77
16"	281	232	199	171	154	143	132	123	106	91
18"	348	286	244	208	187	174	159	148	126	107
20"	422	346	295	250	223	207	190	175	148	125
22"	504	413	350	296	264	244	223	206	173	146
24"	594	485	411	346	308	285	260	239	200	167
26"	-	564	477	401	357	330	300	275	230	191
28"	-	650	549	460	409	377	343	315	262	217
30"	-	741	625	524	465	429	389	357	296	245
32"	-	839	707	592	525	484	439	402	333	274
34"	-	944	795	665	588	542	491	450	372	306
36"	-	1054	887	741	656	604	547	500	414	339

Pipe Size	DR						
	7	9	11	13.5	17	21	26
8"	110	95	84	75	66	60	54
10"	151	127	111	98	85	75	66
12"	201	168	145	126	107	93	82
14"	259	215	185	158	134	115	99
16"	327	269	230	196	164	140	120
18"	403	331	282	239	198	168	143
20"	487	399	339	286	237	199	168
24"	-	556	470	395	325	272	227
30"	-	839	707	592	484	402	333

If Your Cylinders are Orange

Machines: McElroy No. 824, McElroy No. 1236, McElroy TracStar 630, McElroy TracStar 900 (Manifold Equipped)

Cylinders: Orange (Medium Force) - 15.32 in² Piston Area

Heater Surface Temp: 425°F

Interfacial pressure: 75 psi

NOTE: Fusion pressure shown includes 30 psi for system drag.

IPS	Pipe Size	DR									
		7	9	11	13.5	15.5	17	19	21	26	32.5
8"	170	143	125	108	99	93	87	82	72	64	
10"	248	206	177	152	137	128	119	111	96	83	
12"	336	277	237	201	181	168	155	143	122	105	
14"	399	328	279	237	212	197	180	167	141	120	
16"	512	419	355	300	268	248	226	209	176	147	
18"	640	522	442	372	331	306	278	256	214	179	
20"	783	638	538	452	401	371	337	309	258	213	
22"	941	765	645	541	479	442	401	368	305	252	
24"	1,115	905	762	638	565	520	472	432	358	294	
26"	-	1,057	889	743	657	606	548	502	414	340	
28"	-	1,221	1,027	857	758	698	631	577	476	390	
30"	-	1,397	1,174	979	865	796	720	658	542	443	
32"	-	1,585	1,332	1,110	981	902	815	744	612	500	
34"	-	1,786	1,499	1,249	1,103	1,014	916	836	688	560	
36"	-	1,999	1,677	1,397	1,233	1,134	1,024	934	767	624	

DIPS	Pipe Size	DR						
		7	9	11	13.5	17	21	26
8"	184	154	134	116	100	87	77	
10"	262	217	187	160	135	116	100	
12"	358	295	251	214	178	152	129	
14"	471	386	328	277	229	193	163	
16"	600	490	415	349	288	241	202	
18"	746	608	513	431	354	295	246	
20"	909	739	623	522	427	355	295	
24"	-	1,041	876	732	597	494	409	
30"	-	1,585	1,332	1,110	902	744	612	

If Your Cylinders are Yellow

Machines: McElroy No. 824, McElroy No. 1236, McElroy TracStar 630, McElroy TracStar 900 (Manifold Equipped)

Cylinders: Yellow (Low Force) - 9.45 in² Piston Area

Heater Surface Temp: 425°F

Interfacial pressure: 75 psi

NOTE: Fusion pressure shown includes 30 psi for system drag.

IPS	Pipe Size	DR									
		7	9	11	13.5	15.5	17	19	21	26	32.5
8"	257	213	183	157	142	133	122	114	99	85	
10"	383	315	268	228	204	190	174	161	137	116	
12"	526	430	365	308	275	254	232	214	180	151	
14"	628	513	434	365	325	301	274	252	211	176	
16"	812	660	558	468	415	383	348	319	266	220	
18"	1,019	828	698	584	518	477	433	396	329	271	
20"	1,441	1,168	983	820	726	668	605	553	456	374	
22"	1,508	1,222	1,027	858	758	698	632	577	476	390	
24"	1,789	1,448	1,217	1,015	897	825	746	681	561	458	
26"	-	1,695	1,423	1,186	1,047	963	870	794	653	533	
28"	-	1,961	1,646	1,371	1,210	1,112	1,005	917	753	613	
30"	-	2,246	1,885	1,569	1,384	1,272	1,149	1,048	860	699	
32"	-	NC	2,140	1,781	1,571	1,444	1,303	1,188	974	791	
34"	-	NC	NC	2,007	1,770	1,626	1,467	1,337	1,096	890	
36"	-	NC	NC	2,246	1,980	1,819	1,641	1,495	1,225	994	

DIPS	Pipe Size	DR						
		7	9	11	13.5	17	21	26
8"	280	232	199	170	143	123	106	
10"	406	333	284	241	200	169	144	
12"	562	459	389	328	271	227	191	
14"	745	606	512	430	353	295	246	
16"	954	776	654	548	448	372	309	
18"	1,191	966	814	680	555	460	381	
20"	1,454	1,179	991	828	674	558	460	
24"	-	1,669	1,402	1,168	949	783	644	
30"	-	NC	2,140	1,781	1,444	1,188	974	

NC= Not Capable with Yellow Cylinder Machines

If Your Cylinders are Green

Machines: McElroy No.1648, McElroy TracStar 1200,
McElroy No. 2065, McElroy No. 1600

Cylinders: Green (High Force) - 31.42 in² Piston Area

Heater Surface Temp: 425°F

Interfacial pressure: 75 psi

NOTE Fusion pressure shown includes 30 psi for system drag.

Pipe Size	DR									
	7	9	11	13.5	15.5	17	19	21	26	32.5
16"	265	220	189	162	146	136	126	117	101	87
18"	328	270	231	197	177	165	151	140	120	102
20"	397	326	278	236	211	196	180	166	141	119
22"	474	388	330	279	249	231	211	195	164	138
24"	559	457	387	326	291	269	245	226	190	159
26"	-	531	449	378	336	311	283	260	217	181
28"	-	611	516	433	385	355	323	297	247	205
30"	-	697	588	493	437	404	367	336	280	231
32"	-	788	665	557	493	455	413	378	314	259
34"	-	886	746	625	553	510	462	423	351	289
36"	-	990	833	697	617	568	515	471	389	320
42"	-	-	-	937	828	762	690	630	519	425
48"	-	-	-	-	1,073	987	891	814	669	545
54"	-	-	-	-	-	1,241	1,120	1,022	839	682
63"	-	-	-	-	-	1,678	1,514	1,380	1,131	918

Pipe Size	DR						
	7	9	11	13.5	17	21	26
16"	308	254	218	186	156	133	114
18"	379	312	266	226	188	159	135
20"	458	376	319	270	224	189	159
24"	-	523	443	372	306	256	215
30"	-	788	665	557	493	455	413
36"	-	-	939	784	639	529	437
42"	-	-	-	1,049	852	703	579
48"	-	-	-	-	1,101	908	746

If Your Cylinders are Orange

Machines: McElroy No.1648, McElroy TracStar 1200,
McElroy No. 1600

Cylinders: Orange (Medium Force) - 14.14 in² Piston Area

Heater Surface Temp: 425°F

Interfacial pressure: 75 psi

NOTE Fusion pressure shown includes 30 psi for system drag.

Pipe Size	DR									
	7	9	11	13.5	15.5	17	19	21	26	32.5
16"	552	451	383	323	287	266	243	223	188	157
18"	691	563	476	400	356	329	299	275	230	191
20"	846	688	581	487	432	399	362	332	276	229
22"	1,018	827	697	583	517	477	432	396	328	271
24"	1,205	978	823	688	609	561	509	465	385	316
26"	-	1,143	961	803	710	654	592	541	447	366
28"	-	1,320	1,110	926	818	753	681	622	513	420
30"	-	1,511*	1,269	1,059	935	860	778	710	585	477
32"	-	1,715*	1,440	1,200	1,060	975	881	804	661	539
34"	-	1,932*	1,622*	1,351	1,193	1,096	990	904	742	604
36"	-	2,163*	1,815*	1,511*	1,333	1,226	1,107	1,009	829	674
42"	-	-	-	2,046*	1,804*	1,657*	1,496	1,363	1,117	907
48"	-	-	-	-	2,347*	2,156*	1,944	1,771	1,450	1,175
54"	-	-	-	-	-	2,720	2,453	2,234	1,827	1,479
63"	-	-	-	-	-	NC	NC	NC	2,476	2,002

Pipe Size	DR						
	7	9	11	13.5	17	21	26
16"	648	528	447	376	309	259	217
18"	806	656	554	465	381	317	264
20"	982	798	673	563	460	383	318
24"	-	1,125	947	791	644	533	440
30"	-	1,715*	1,440	1,200	975	804	661
36"	-	-	2,050*	1,706*	1,383	1,139	934
42"	-	-	-	2,293*	1,857*	1,526*	1,250
48"	-	-	-	-	2,411	1,980	1,620

NC = Not Capable with Orange Cylinder Machines

* Exceeds capacity of 1648/TracStar 1200. Consider using either green cylinder 1648/TracStar 1200 or orange cylinder 1600 machines.

Temperature Conversions

Temperature Conversions			
Fahrenheit	Celsius	Fahrenheit	Celsius
0	-18	260	127
10	-12	270	132
20	-7	280	138
30	-1	290	143
40	4	300	149
50	10	310	154
60	16	320	160
70	21	330	165
80	27	340	171
90	32	350	176
100	38	360	182
110	43	370	188
120	49	380	193
130	54	390	199
140	60	400	204
150	65	410	210
160	71	420	215
170	77	430	221
180	82	440	226
190	88	450	232
200	93	460	238
210	99	470	243
220	104	480	249
230	110	490	254
240	115	500	260
250	121	510	265

Conversion Formulas

Inches	X	25.40	= Millimeters
Millimeters	X	0.03937	= Inches
Feet	X	304.8	= Millimeters
Millimeters	X	.003280839	= Feet
SQ. Inches	X	645.16	= SQ. Millimeters
SQ. Millimeters	X	.00155	= SQ. Inches
Ounces (fluid) US	X	0.02957	= Liters
Quarts	X	0.9463	= Liters
Liters	X	1.057	= Quarts
Gallons	X	3.785	= Liters
Liters	X	0.2642	= Gallons (fluid) US
Pounds	X	0.4536	= Kilograms
Kilograms	X	2.205	= Pounds
Bar	X	14.503	= Psi
mPa ²	X	145.03	= Psi
Kg/cm ²	X	14.223	= Psi

References

ASTM 2620-13

Standard Practice for Heat Fusion Joining of Polyethylene Pipe and Fittings, 2013

Plastics Pipe Institute Technical Report-33

Generic Butt Fusion Joining Procedure for Polyethylene Gas Pipe, 2012

Plastics Pipe Institute Technical Report-41

Generic Saddle Fusion Joining Procedure for Polyethylene Gas Pipe, 2002

Plastics Pipe Institute Technical Note-42

Recommended Minimal training Guidelines for PE Pipe Butt Fusion Joining Operators for Municipal and Industrial Projects. March 2015

ASTM D2657-07 (2015)

Standard Practice for Heat Fusion Joining of Polyolefin Pipe and Fittings. Volume 8.04. American Society of Testing and Materials. Baltimore.

ASTM F1056-04 (2011)

Standard Specification for Socket Fusion Tools for Use in Socket Fusion Joining Polyethylene Pipe or Tubing and Fittings. Volume 8.04. American Society of Testing and Materials. Baltimore.

Acknowledgements

McElroy Manufacturing, Inc.
Plastics Pipe Institute (PPI)
American Society for Testing Materials (ASTM)

Brand and product names are trademarks of their respective owners.

FUSION EQUIPMENT FOR SALE, RENT OR LEASE:

- Butt Fusion Machines
- Sidewall Fusion Machines
- Socket Fusion Equipment
- Limited Access Fusion Machines
- Productivity Tools
- QA/QC Tools
- Accessories and Special Tools
- Coiled Pipe Trailers
- Electrofusion Equipment
- Extrusion Welders
- Hot Air Guns

RENTAL & SALES LOCATIONS

Rental and sales locations across the US, as well as Australia, Canada and South America.



We offer finance/lease options toward the purchase of new and used equipment.

We offer trade-in and trade-up plans to keep your fleet more reliable & current.

EQUIPMENT REPAIR AND REFURBISHMENT

We rebuild and refurbish McElroy fusion equipment using a team of McElroy Master Mechanics.

Multiple McElroy Authorized Service and Repair Centers to support you and your equipment.

We offer McElroy DataLogger™ repair and calibration.

Equipment troubleshooting and diagnostic assistance available through the ISCO Fusion Hotline at 1.800.345.4726 ext. 4790.



FUSION TRAINING AND SERVICES

With our team of McElroy certified “Train the Trainers,” we can train operators to the latest advancements and proper fusion techniques.



Jobsite training available by field fusion technicians who are experienced, qualified and hold McElroy fusion training certifications.

Additional certification held by most of our technicians include; OSHA 40-hour hazwoper, OSHA construction 10-hour safety training, OSHA confined space, MSHA part 46, MSHA part 48 and Red Cross first aid/CPR certifications.

Fusion questions can be answered at the ISCO Fusion Hotline by calling 1.800.345.4726 ext. 4790.





**100 Witherspoon Street 2West
Louisville, KY 40202**

T. 800.345.4726

F. 800.831.4726

isco-pipe.com

